

Dell PowerEdge T430 Owner's Manual

Regulatory Model: E30S Series
Regulatory Type: E30S001



Notes, Cautions, and Warnings

 **NOTE:** A NOTE indicates important information that helps you make better use of your computer.

 **CAUTION:** A CAUTION indicates either potential damage to hardware or loss of data and tells you how to avoid the problem.

 **WARNING:** A WARNING indicates a potential for property damage, personal injury, or death.

Copyright © 2014 Dell Inc. All rights reserved. This product is protected by U.S. and international copyright and intellectual property laws. Dell™ and the Dell logo are trademarks of Dell Inc. in the United States and/or other jurisdictions. All other marks and names mentioned herein may be trademarks of their respective companies.

2014 - 10

Rev. A00

Contents

1 About your system.....	9
Front-panel features and indicators.....	10
LCD panel features.....	16
Home screen.....	16
Setup menu.....	17
View menu.....	17
Diagnostic indicators.....	17
Hard-drive indicator codes.....	19
Back-panel features and indicators.....	20
NIC indicator codes.....	22
Indicator codes for redundant power supply.....	22
Indicator codes for non-redundant power supply.....	24
Documentation matrix.....	25
Quick Resource Locator.....	25
2 Performing initial system configuration	27
Setting up your system.....	27
Setting up and configuring the iDRAC IP address	27
Logging in to iDRAC.....	27
Installing the operating system.....	28
Managing your system remotely.....	28
Downloading and installing drivers and firmware.....	28
3 Pre-operating system management applications.....	30
Navigation keys.....	30
About System Setup.....	30
Entering System Setup.....	31
System Setup Main Menu.....	31
System BIOS screen.....	31
System Information screen.....	32
Memory Settings screen.....	32
Processor Settings screen.....	33
SATA Settings screen.....	34
Boot Settings screen.....	37
Network Settings screen.....	37
Integrated Devices screen details.....	38
Serial Communication screen.....	39
System Profile Settings screen.....	40

System Security Settings screen.....	41
Miscellaneous Settings screen.....	43
About Boot Manager.....	43
Entering Boot Manager	43
Boot Manager main menu.....	43
About Dell Lifecycle Controller.....	44
Changing the boot order.....	44
Choosing the system boot mode.....	44
Assigning a system and setup password.....	45
Using your system password to secure your system.....	46
Deleting or changing an existing system password and setup password.....	46
Operating with a setup password enabled.....	47
Embedded system management.....	47
iDRAC Settings utility.....	47
Entering the iDRAC Settings utility.....	47
Changing the Thermal Settings.....	48

4 Installing and removing system components.....49

Safety instructions.....	49
Before working inside your system.....	49
After working inside your system.....	49
Recommended tools.....	50
Front bezel (optional).....	50
Installing the front bezel.....	50
Removing the front bezel.....	51
System feet.....	51
Removing the system feet.....	51
Installing the system feet.....	52
Caster wheels (optional)—tower mode.....	53
Installing caster wheels.....	53
Removing caster wheels.....	54
Removing the system cover.....	55
Installing the system cover.....	56
Inside the system.....	56
Optical drives and tape drives (optional).....	57
Removing the optical drive or tape drive.....	58
Installing the optical drive or tape drive.....	61
Cooling shroud.....	61
Removing the cooling shroud.....	61
Installing the cooling shroud.....	62
Hot-swappable hard drives.....	63
Removing a hot-swap hard drive.....	64

Installing a hot-swap hard drive.....	65
Removing a hard-drive blank.....	65
Installing a hard-drive blank.....	66
Installing a 2.5 inch hard drive into a 3.5 inch hard-drive adapter.....	67
Removing a 2.5 inch hard drive from a 3.5 inch hard-drive adapter.....	68
Installing a hard-drive adapter into a hard-drive carrier.....	68
Removing a hard-drive adapter from a hard-drive carrier.....	69
Removing a hard drive from a hard-drive carrier.....	69
Installing a hard drive into a hard-drive carrier.....	70
Cabled hard drives.....	70
Removing the internal hard-drive bay.....	71
Installing the internal hard-drive bay.....	72
Removing a cabled hard drive.....	72
Installing a cabled hard drive.....	76
Hard-drive backplane.....	76
Removing the hard-drive backplane	77
Installing the hard-drive backplane.....	82
Four-slot hard-drive blank.....	82
Removing a four-slot hard-drive blank.....	82
Installing a four-slot hard-drive blank.....	83
System memory.....	84
General memory module installation guidelines.....	86
Mode-specific guidelines.....	86
Sample memory configurations.....	87
Removing memory modules.....	89
Installing memory modules.....	90
Cooling fans.....	92
Removing the internal cooling fan.....	92
Installing the internal cooling fan.....	93
Removing the external cooling fan	94
Installing the external cooling fan.....	95
Internal USB memory key (optional).....	96
Replacing the internal USB key.....	96
Expansion card holder.....	97
Removing the expansion card holder.....	97
Installing the expansion card holder.....	98
Expansion cards.....	98
Expansion card installation guidelines.....	99
GPU card installation guidelines.....	100
Removing an expansion card.....	100
Installing an expansion card.....	102
Removing a GPU card.....	103

Installing a GPU card.....	104
iDRAC ports card (optional).....	105
Removing the iDRAC ports card.....	105
Installing the iDRAC ports card.....	106
Replacing an SD vFlash media card.....	107
Internal dual SD module.....	108
Removing the internal dual SD module	108
Installing the internal dual SD module	110
Internal SD card.....	110
Removing an internal SD card.....	110
Installing an internal SD card.....	111
Processors.....	111
Removing a processor.....	112
Installing a processor.....	116
Redundant AC power supply.....	118
Hot Spare feature.....	118
Removing a redundant AC power supply.....	119
Installing a redundant AC power supply	120
Removing the power supply unit blank.....	121
Installing the power supply unit blank.....	122
Replacing the power supply divider.....	122
Non-redundant AC power supply.....	123
Removing a non-redundant AC power supply.....	124
Installing a non-redundant AC power supply.....	125
Power interposer board.....	126
Removing the power interposer board.....	126
Installing the power interposer board.....	127
System battery.....	128
Replacing the system battery.....	128
Control panel assembly.....	129
Removing the control panel assembly.....	129
Installing the control panel assembly.....	131
Removing the control panel assembly cover.....	132
Installing the control panel assembly cover.....	133
Removing the control-panel board.....	134
Installing the control-panel board.....	135
Removing the LCD module.....	136
Installing the LCD module.....	137
Removing the VGA module.....	138
Installing the VGA module.....	139
System board.....	139
Removing the system board.....	139

Installing the system board.....	143
Restoring the Service Tag using Easy Restore.....	144
Entering the system Service Tag using System Setup.....	144
Trusted Platform Module.....	145
Installing the Trusted Platform Module	145
Re-enabling the TPM for BitLocker users.....	146
Re-enabling the TPM for TXT users.....	146
System top cover.....	147
Removing the system top cover.....	147
Installing the system top cover.....	148

5 Converting the system from tower mode to rack mode..... 149

Safety instructions.....	149
Preparing a system for conversion from tower mode to rack mode.....	149

6 Troubleshooting your system..... 152

Safety first—for you and your system.....	152
Troubleshooting system startup failure.....	152
Troubleshooting external connections.....	152
Troubleshooting the video subsystem.....	152
Troubleshooting a USB device.....	152
Troubleshooting iDRAC Direct (USB XML configuration).....	153
Troubleshooting iDRAC Direct (laptop connection).....	154
Troubleshooting a serial I/O device.....	154
Troubleshooting a NIC.....	154
Troubleshooting a wet system.....	155
Troubleshooting a damaged system.....	156
Troubleshooting the system battery.....	156
Troubleshooting power supply units.....	157
Power source problems.....	157
Power supply unit problems.....	157
Troubleshooting cooling problems.....	158
Troubleshooting cooling fans.....	158
Troubleshooting system memory.....	159
Troubleshooting an internal USB key.....	160
Troubleshooting an SD card.....	160
Troubleshooting an optical drive.....	161
Troubleshooting a tape backup unit.....	162
Troubleshooting a hard drive.....	162
Troubleshooting a storage controller.....	163
Troubleshooting expansion cards.....	164
Troubleshooting processors.....	164

System messages.....	165
Warning messages.....	165
Diagnostic messages.....	165
Alert messages.....	165
7 Using system diagnostics.....	166
Dell Embedded System Diagnostics.....	166
When to use the Embedded System Diagnostics.....	166
Running the Embedded System Diagnostics from Boot Manager.....	166
Running the Embedded System Diagnostics from the Dell Lifecycle Controller.....	166
System diagnostic controls.....	167
8 Jumpers and connectors.....	168
System board connectors.....	168
System board jumper settings.....	170
Disabling a forgotten password.....	170
9 Technical Specifications.....	172
10 Getting help.....	178
Contacting Dell.....	178
Locating your system Service Tag.....	178
Quick Resource Locator.....	178

About your system

The Dell PowerEdge T430 is a rackable tower server that supports up to two processors based on the Intel Xeon E5-2600 v3 processor family, up to 12 DIMMs, and storage capacity of up to 16 hard drives/SSDs.

The T430 is available in the following configurations:

System	Configuration
3.5 inch hard-drive system	Up to four 3.5 inch cabled hard drives Up to eight 3.5 inch hot-swappable hard drives
2.5 inch hard-drive system	Up to sixteen 2.5 inch hot-swappable hard drives

Front-panel features and indicators

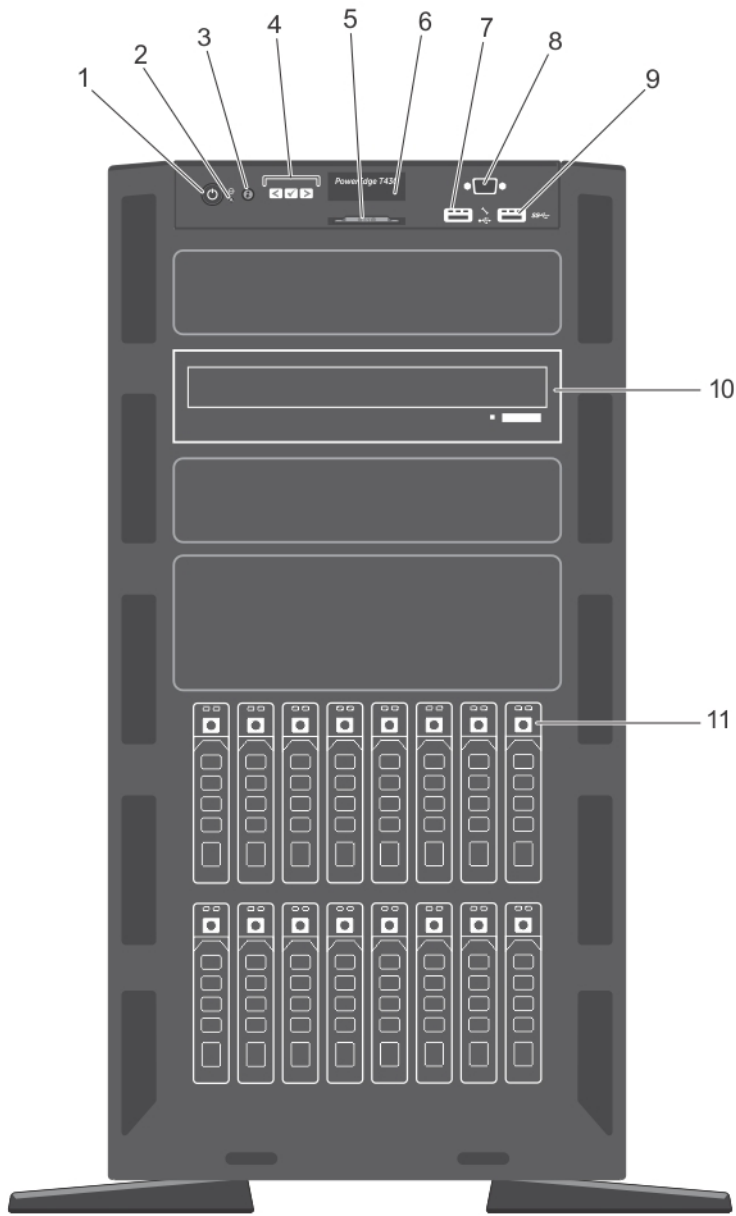

Figure 1. Front-panel features and indicators— 2.5 inch hot-swap hard-drive chassis

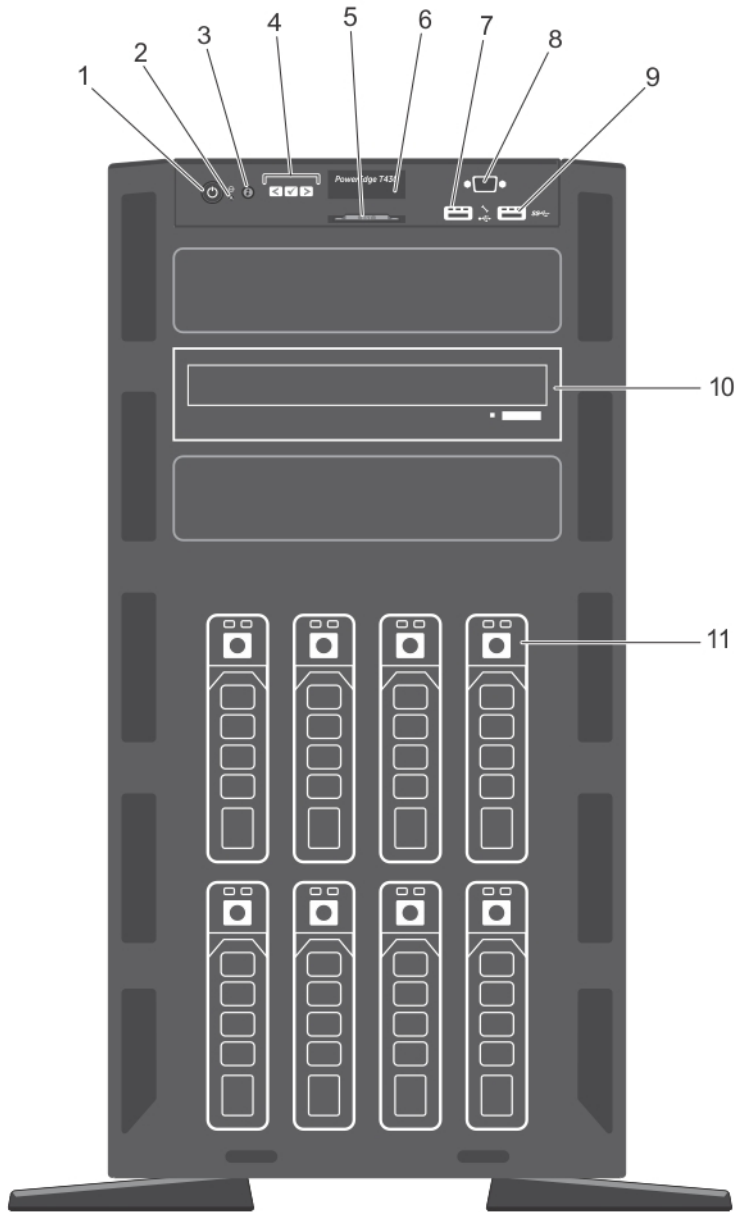









Figure 2. Front-panel features and indicators— 3.5 inch hot-swap hard-drive chassis

Item	Indicator, button, or connector	Icon	Description
1	Power-on indicator, power button		The power-on indicator lights when the system power is on. The power button controls the power supply output to the system.

Item	Indicator, button, or connector	Icon	Description
			 NOTE: On ACPI-compliant operating systems, turning off the system using the power button causes the system to perform a graceful shutdown before power to the system is turned off.
2	NMI button		<p>Used to troubleshoot software and device driver errors when running certain operating systems. This button can be pressed using the end of a paper clip.</p> <p>Use this button only if directed to do so by qualified support personnel or by the operating system documentation.</p>
3	System identification button		<p>The identification buttons on the front and back panels can be used to locate a particular system within a rack. When one of these buttons is pressed, the LCD panel on the front and the system status indicator on the back flash until one of the buttons is pressed again.</p> <p>Press to toggle the system ID on and off.</p> <p>If the system stops responding during POST, press and hold the system ID button for more than five seconds to enter BIOS progress mode.</p> <p>To reset iDRAC (if not disabled in <F2> iDRAC setup) press and hold for more than 15 seconds.</p>
4	LCD menu buttons		Allow you to navigate the control panel LCD menu.
5	Information tag		A slide-out label panel which contains system information such as Service Tag, NIC, MAC address, and so on for your reference.
6	LCD panel		<p>Displays system ID, status information, and system error messages. See LCD panel features.</p> <p> NOTE: The LCD panel is not available in a cabled hard-drive system.</p>
7	USB management port/ iDRAC Direct port		<p>The USB management port can function as a regular USB port or provide access to the iDRAC Direct features. For more information, see the iDRAC Guide at dell.com/esmmanuals.</p> <p>This port is USB 2.0-compliant</p>
8	Video connector		Allows you to connect a display to the system.

Item	Indicator, button, or connector	Icon	Description
			 NOTE: The video connector is available only in the rack-mode configuration of your system. For information on converting your system from tower to the rack mode, see Preparing a system for conversion from tower mode to rack mode .
9	USB connector		Allows you to connect USB devices to the system. This port is USB 3.0-compliant.
10	Optical drive or tape-drive bay		Allows you to install optical drives or tape drives. For more information on supported optical drives and tape drives, see Optical drives and tape drives (optional) .
11	Physical drives		3.5 inch hard drives and 2.5 inch hard drives/SSDs.

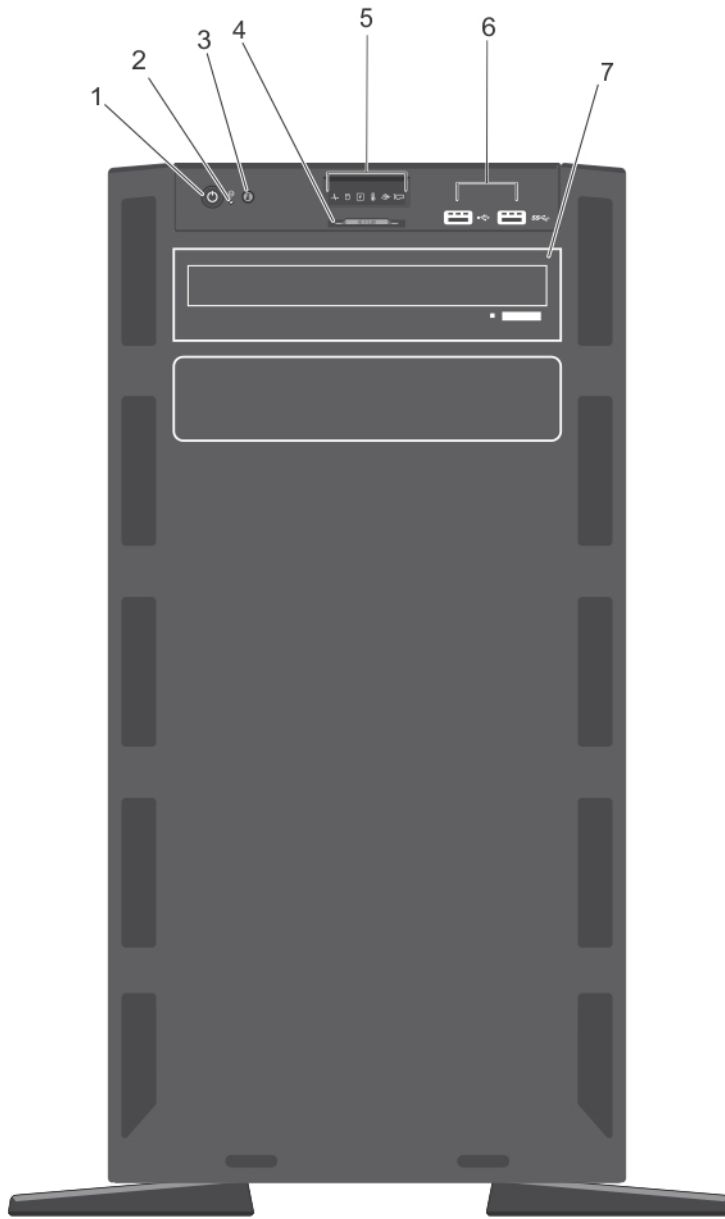







Figure 3. Front-panel features and indicators— 3.5 inch cabled hard-drive chassis

Item	Indicator, Button, or Connector	Icon	Description
1	Power-on indicator, power button		The power-on indicator lights when the system power is on. The power button controls the power supply output to the system.

Item	Indicator, Button, or Connector	Icon	Description
			 NOTE: On ACPI-compliant operating systems, turning off the system using the power button causes the system to perform a graceful shutdown before power to the system is turned off.
2	NMI button		<p>Used to troubleshoot software and device driver errors when running certain operating systems. This button can be pressed using the end of a paper clip.</p> <p>Use this button only if directed to do so by qualified support personnel or by the operating system documentation.</p>
3	System identification button		<p>The identification buttons on the front and back panels can be used to locate a particular system within a rack. When one of these buttons is pressed, the LCD panel on the front and the system status indicator on the back flash until one of the buttons is pressed again.</p> <p>Press to toggle the system ID on and off.</p> <p>If the system stops responding during POST, press and hold the system ID button for more than five seconds to enter BIOS progress mode.</p> <p>To reset iDRAC (if not disabled in <F2> iDRAC setup) press and hold for more than 15 seconds.</p>
4	Information tag		A slide-out label panel which contains system information such as Service Tag, NIC, MAC address, and so on for your reference.
5	Diagnostic indicators		The diagnostic indicators on the system front panel display error status during system startup. For more information, see Diagnostic indicators .
6	USB connectors	 	Allows you to connect USB devices to the system. One port is USB 2.0-compliant and one port is USB 3.0-compliant.
7	Optical drive or tape-drive bay		Allows you to install optical drives or tape drives. For more information on supported optical drives and tape drives, see Optical drives and tape drives (optional) .

LCD panel features

The system's LCD panel provides system information and status and error messages to indicate if the system is operating correctly or if the system needs attention. For more information on error messages, see the Dell Event and Error Messages Reference Guide at dell.com/esmmanuals.

- The LCD backlight lights blue during normal operating conditions.
- When the system needs attention, the LCD lights amber, and displays an error code followed by descriptive text.
 - ✎ **NOTE:** If the system is connected to a power source and an error is detected, the LCD lights amber regardless of whether the system is turned on or off.
- The LCD backlight turns OFF when the system is in standby mode and can be turned on by pressing either the Select, Left, or Right button on the LCD panel.
- The LCD backlight remains OFF if LCD messaging is turned off through the iDRAC utility, the LCD panel, or other tools.

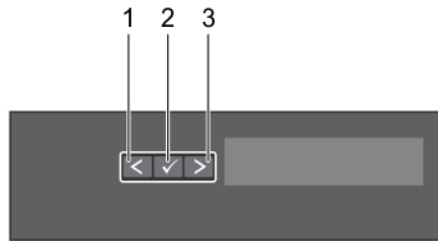



Figure 4. LCD panel features

Item	Button	Description
1	Left	Moves the cursor back in one-step increments.
2	Select	Selects the menu item highlighted by the cursor.
3	Right	Moves the cursor forward in one-step increments. During message scrolling: <ul style="list-style-type: none">• Press once to increase scrolling speed• Press again to stop• Press again to return to the default scrolling speed• Press again to repeat the cycle

Home screen

The Home screen displays user-configurable information about the system. This screen is displayed during normal system operation when there are no status messages or errors. When the system is in standby mode, the LCD backlight turns off after five minutes of inactivity if there are no error messages. Press one of the three navigation buttons (Select, Left, or Right) to view the Home screen.

To navigate to the Home screen from another menu, continue to select the up arrow  until the Home icon  is displayed, and then select the Home icon.

From the Home screen, press the Select button to enter the main menu.

Setup menu

 **NOTE:** When you select an option in the Setup menu, you must confirm the option before proceeding to the next action.

Option	Description
iDRAC	Select DHCP or Static IP to configure the network mode. If Static IP is selected, the available fields are IP , Subnet (Sub) , and Gateway (Gtw) . Select Setup DNS to enable DNS and to view domain addresses. Two separate DNS entries are available.
Set error	Select SEL to display LCD error messages in a format that matches the IPMI description in the SEL. This is useful when trying to match an LCD message with an SEL entry. Select Simple to display LCD error messages in a simplified user-friendly description. See the <i>Dell Event and Error Messages Reference Guide</i> at dell.com/esmmanuals for the list of messages in this format.
Set home	Select the default information to be displayed on the LCD Home screen. See View Menu to see the options and option items that can be set as the default on the Home screen.

View menu







 **NOTE:** When you select an option in the View menu, you must confirm the option before proceeding to the next action.

Option	Description
iDRAC IP	Displays the IPv4 or IPv6 addresses for the iDRAC7. Addresses include DNS (Primary and Secondary) , Gateway , IP , and Subnet (IPv6 does not have Subnet).
MAC	Displays the MAC addresses for iDRAC , iSCSI , or Network devices.
Name	Displays the name of the Host , Model , or User String for the system
Number	Displays the Asset tag or the Service tag for the system.
Power	Displays the power output of the system in BTU/hr or Watts. The display format can be configured in the Set home submenu of the Setup menu.
Temperature	Displays the temperature of the system in Celsius or Fahrenheit. The display format can be configured in the Set home submenu of the Setup menu.

Diagnostic indicators

The diagnostic indicators on the system front panel display error status during system startup.

 **NOTE:** No diagnostic indicators are lit when the system is switched off. To start the system, plug it into a working power source and press the power button.

Icon	Description	Condition	Corrective action
	Health indicator	<p>If the system is on, and in good health, the indicator lights solid blue.</p> <p>The indicator blinks amber if the system is on or in standby, and if any error exists (for example, a failed fan or hard drive).</p>	<p>None required.</p> <p>See the System Event Log or system messages for the specific issue. For more information on error messages, see the Dell Event and Error Messages Reference Guide at dell.com/esmmanuals.</p> <p>Invalid memory configurations can cause the system to halt at startup without any video output. See Getting help.</p>
	Hard-drive indicator	The indicator blinks amber if a hard drive experiences an error.	See the System Event Log to determine the hard drive that has an error. Run the appropriate Online Diagnostics test. Restart system and run embedded diagnostics (ePSA). If the hard drives are configured in a RAID array, restart the system and enter the host adapter configuration utility program.
	Electrical indicator	The indicator blinks amber if the system experiences an electrical error (for example, voltage out of range, or a failed power supply or voltage regulator).	See the System Event Log or system messages for the specific issue. If it is due to a problem with the power supply, check the LED on the power supply. Re-seat the power supply by removing and reinstalling it. If the problem persists, see Getting help .
	Temperature indicator	The indicator blinks amber if the system experiences a thermal error (for example, a temperature out of range or fan failure).	<p>Ensure that none of the following conditions exist:</p> <ul style="list-style-type: none"> • A cooling fan is removed or has failed. • System cover, cooling shroud, EMI filler panel, memory-module blank, or back-filler bracket is removed. • Ambient temperature is too high. • External airflow is obstructed. <p>See Getting help.</p>
	Memory indicator	The indicator blinks amber if a memory error occurs.	See the system event log or system messages for the location of the failed memory. Reinstall the memory device. If the problem persists, see Getting help .
	PCIe indicator	The indicator blinks amber if a PCIe card experiences an error.	Restart the system. Update any required drivers for the PCIe card. Re-install the card. If the problem persists, see Getting help .

Hard-drive indicator codes

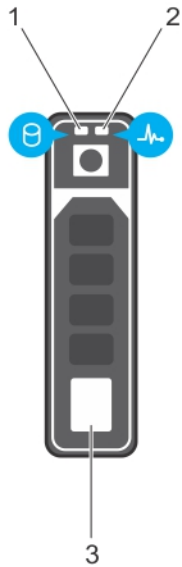

Figure 5. Hard-drive indicators

1. hard-drive activity indicator
2. hard-drive status indicator
3. hard drive

NOTE: If the hard drive is in Advanced Host Controller Interface (AHCI) mode, the status indicator (on the right side) does not function and remains off.

Drive-status indicator pattern (RAID only)	Condition
Blinks green two times per second	Identifying drive or preparing for removal.
Off	Drive ready for insertion or removal.
	NOTE: The drive status indicator remains off until all hard drives are initialized after the system is turned on. Drives are not ready for insertion or removal during this time.
Blinks green, amber, and turns off	Predicted drive failure
Blinks amber four times per second	Drive failed
Blinks green slowly	Drive rebuilding
Steady green	Drive online
Blinks green three seconds, amber three seconds, and turns off six seconds	Rebuild aborted

Back-panel features and indicators

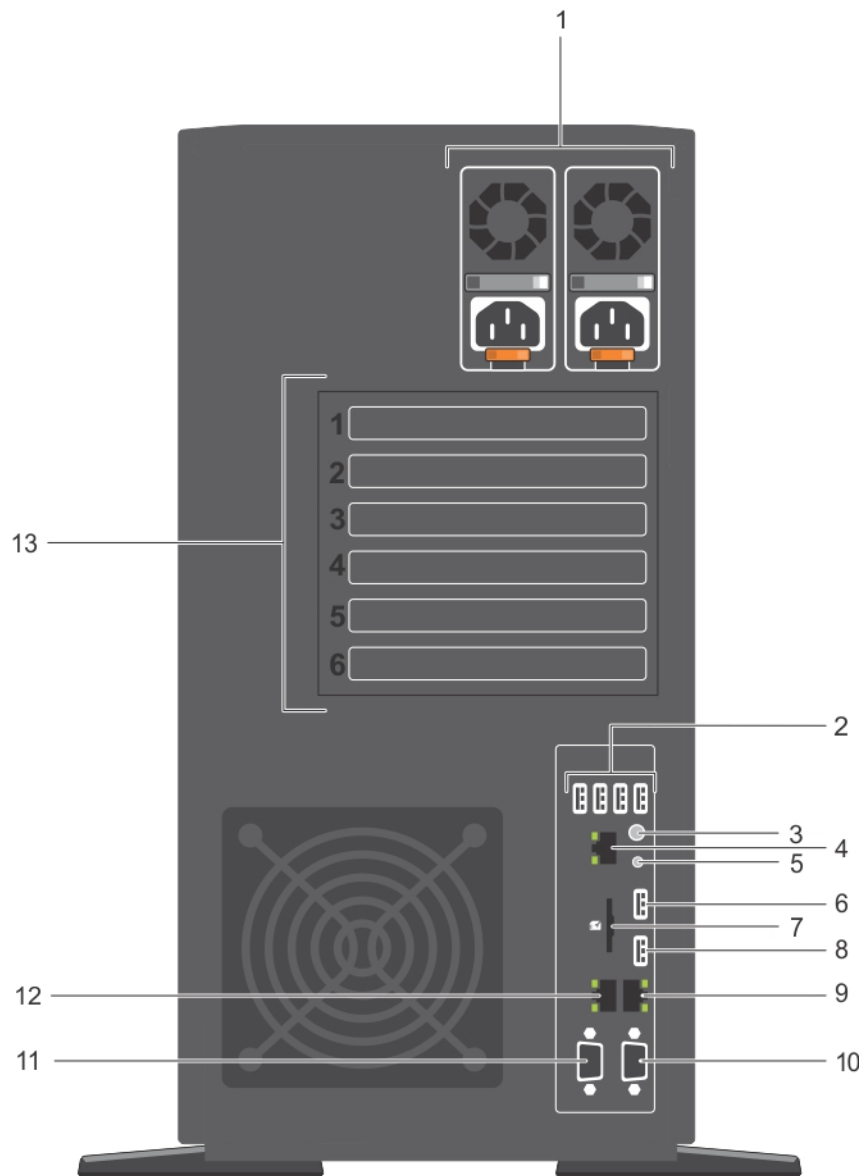









Figure 6. Back-panel features and indicators

Item	Indicator, button, or connector	Icon	Description
1	Power supplies (PSU1 and PSU2)		Redundant power supply Up to two 495 W, 750 W, or 1100 W redundant AC power supplies.

Item	Indicator, button, or connector	Icon	Description
			<p>Non-redundant power supply One 450 W non-redundant AC power supply.</p> <p> NOTE: Non-redundant power supply is supported in systems with cabled hard drives and systems with an x8 backplane.</p>
2, 6, 8	USB connectors (6)		Allows you to connect USB devices to the system. Five ports are USB 2.0-compliant and one port is USB 3.0-compliant.
3	System identification button		<p>The identification buttons on the front and back panels can be used to locate a particular system within a rack. When one of these buttons is pressed, the LCD panel on the front and the system status indicator on the back flash until one of the buttons is pressed again.</p> <p>Press to toggle the system ID on and off.</p> <p>If the system stops responding during POST, press and hold the system ID button for more than five seconds to enter the BIOS progress mode.</p> <p>To reset iDRAC (if not disabled in F2 iDRAC setup), press and hold for more than 15 seconds.</p>
4	iDRAC port (optional)		Dedicated management port on the iDRAC ports card.
5	System identification connector		Allows you to connect the optional system status indicator assembly through the optional cable management arm.
7	vFlash media card slot (optional)		Allows you to insert a vFlash media card.
9, 12	Ethernet connectors (2)		Two integrated 10/100/1000 Mbps NIC connectors.
10	Video connector		Allows you to connect a VGA display to the system.
11	Serial connector		Allows you to connect a serial device to the system.
13	PCIe expansion card slots (6)		Allows you to connect up to six full-height PCI expansion cards.

NIC indicator codes

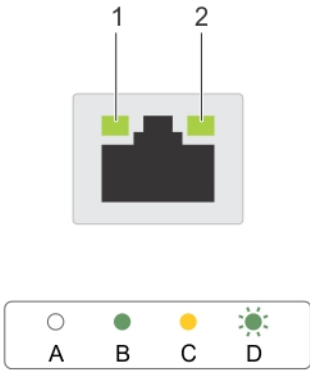

Figure 7. NIC indicators

- 1. link indicator
- 2. activity indicator

Convention	Indicator pattern	Description
A	Link and activity indicators are OFF	The NIC is not connected to the network.
B	Link indicator is green	The NIC is connected to a valid network at its maximum port speed (1 Gbps).
C	Link indicator is yellow	The NIC is connected to a valid network at less than its maximum port speed.
D	Activity indicator is blinking green	Network data is being sent or received.

Indicator codes for redundant power supply

Each AC power supply has an illuminated translucent handle that indicates whether power is present or whether a power fault has occurred.



Figure 8. AC power supply status indicator

1. AC power supply status indicator/handle

Convention	Power Indicator Pattern	Description
A	Green	A valid power source is connected to the power supply and the power supply is operational.
B	Flashing green	When the firmware of the power supply unit is being updated, the power supply handle flashes green. ⚠ CAUTION: Do not disconnect the power cord or unplug the power supply unit when updating firmware. If firmware update is interrupted, the power supply units will not function. You must roll back the power supply firmware by using Life cycle controller. See <i>Dell Lifecycle Controller User's Guide</i> at dell.com/esmmanuals.
C	Flashing green and turns off	When hot-adding a power supply unit, the power supply handle flashes green five times at 4 Hz rate and turns off. This indicates that there is a power supply mismatch with respect to efficiency, feature set, health status, and supported voltage. Replace the power supply with a power supply that matches the capacity of the power supply. ⚠ CAUTION: For AC power supplies, use only PSUs with the Extended Power Performance (EPP) label on the back. Mixing PSUs from previous generations of PowerEdge servers can result in a PSU mismatch condition or failure to power on.
D	Flashing amber	Indicates a problem with the power supply unit.

Convention	Power Indicator Pattern	Description
		<p>⚠ CAUTION: When correcting a power supply mismatch, replace only the power supply with the flashing indicator. Swapping the other power supply to make a matched pair can result in an error condition and unexpected system shutdown. To change from a High Output configuration to a Low Output configuration or vice versa, you must power down the system.</p> <p>⚠ CAUTION: AC power supplies support both 220 V and 110 V input voltages with the exception of Titanium power supplies, which support only 220 V. When two identical power supplies receive different input voltages, they can output different wattages, and trigger a mismatch.</p> <p>⚠ CAUTION: If two power supplies are used, they must be of the same type and have the same maximum output power.</p> <p>⚠ CAUTION: Combining AC and DC power supplies is not supported and triggers a mismatch.</p>
E	Not lit	Power is not connected.

Indicator codes for non-redundant power supply

Press the self-diagnostic button to perform a quick health check on the non-redundant power supply of the system.

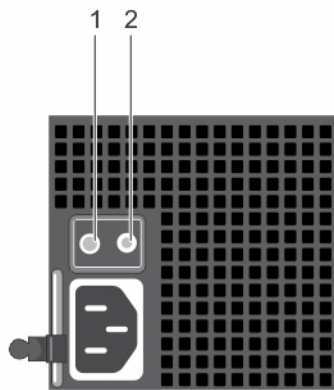

Figure 9. Non-redundant AC power supply status indicator and self-diagnostic button

1. self-diagnostic button
2. AC power supply status indicator

Diagnostic Indicator Pattern	Description
Not lit	Power is not connected or power supply is faulty.
Green	A valid power source is connected to the power supply and the power supply is operational.

Documentation matrix

The documentation matrix provides information on documents that you can refer to for setting up and managing your system.

To...	Refer to...
Install your system into a rack	Rack documentation included with your rack solution
Set up your system and know the system technical specifications	<i>Getting Started With Your System</i> that shipped with your system or see dell.com/poweredgemanuals
Install the operating system	Operating system documentation at dell.com/operatingsystemmanuals
Get an overview of the Dell Systems Management offerings	Dell OpenManage Systems Management Overview Guide at dell.com/openmanagemanuals
Configure and log in to iDRAC, set up managed and management system, know the iDRAC features and troubleshoot using iDRAC	Integrated Dell Remote Access Controller User's Guide at dell.com/esmmanuals
Know about the RACADM subcommands and supported RACADM interfaces	RACADM Command Line Reference Guide for iDRAC and CMC at dell.com/esmmanuals
Launch, enable and disable Lifecycle Controller, know the features, use and troubleshoot Lifecycle Controller	Dell Lifecycle Controller User's Guide at dell.com/esmmanuals
Use Lifecycle Controller Remote Services	Dell Lifecycle Controller Remote Services Quick Start Guide at dell.com/esmmanuals
Set up, use, and troubleshoot OpenManage Server Administrator	Dell OpenManage Server Administrator User's Guide at dell.com/openmanagemanuals
Install, use and troubleshoot OpenManage Essentials	Dell OpenManage Essentials User's Guide at dell.com/openmanagemanuals
Know the features of the storage controller cards, deploy the cards, and manage the storage subsystem	Storage controller documentation at dell.com/storagecontrollermanuals
Check the event and error messages generated by the system firmware and agents that monitor system components	Dell Event and Error Messages Reference Guide at dell.com/esmmanuals

Quick Resource Locator

Use the Quick Resource Locator (QRL) to get immediate access to system information and how-to videos. This can be done by visiting dell.com/QRL or by using your smartphone or tablet and a model specific Quick Resource (QR) code located on your Dell PowerEdge system. To try out the QR code, scan the following image.



Quick Resource Locator



www.dell.com/QRL/Server/T430

Performing initial system configuration

After you receive your PowerEdge system, you must set up your system, install the operating system if it is not pre-installed, and set up and configure the system iDRAC IP address.

Setting up your system

1. Unpack the server.
2. Install the server into the rack. For more information on installing the server into the rack, see your system *Rack Installation Placemat* at dell.com/poweredgemanuals. For tower systems that can be converted to the rack mode, see [Preparing a system for conversion from tower mode to rack mode](#) to know how to convert the tower system to the rack mode configuration.
3. Connect the peripherals to the system.
4. Connect the system to its electrical outlet.
5. Turn the system on by pressing the power button or using iDRAC.
6. Turn on the attached peripherals.

Setting up and configuring the iDRAC IP address

You can set up the Integrated Dell Remote Access Controller (iDRAC) IP address by using one of the following interfaces:

- iDRAC Settings utility
- Lifecycle Controller
- Dell OpenManage Deployment Toolkit
- Server LCD panel

You can configure iDRAC IP address by using the following interfaces:

- iDRAC Web interface. For more information, see the Integrated Dell Remote Access Controller User's Guide.
- Remote Access Controller Admin (RACADM). For more information, see the RACADM Command Line Interface Reference Guide and the Integrated Dell Remote Access Controller User's Guide.
- Remote Services that includes Web Services Management (WS-Man). For more information, see the Lifecycle Controller Remote Services Quick Start Guide.

For more information on setting up and configuring iDRAC, see the Integrated Dell Remote Access Controller User's Guide at dell.com/esmmanuals.

Logging in to iDRAC

You can log in to iDRAC as an iDRAC local user, a Microsoft Active Directory user, or a Lightweight Directory Access Protocol (LDAP) user. You can also log in by using Single Sign-On or a Smart Card. The

default user name is **root** and password is **calvin**. For more information on logging in to iDRAC and iDRAC licenses, see the Integrated Dell Remote Access Controller User's Guide at dell.com/esmmanuals.

You can also access iDRAC using RACADM. For more information, see the RACADM Command Line Interface Reference Guide and the Integrated Dell Remote Access Controller User's Guide available at dell.com/esmmanuals.

Installing the operating system

If the server is shipped without an operating system, install the supported operating system on the server by using one of the following methods:

- Dell Systems Management Tools and Documentation media. See the operating system documentation at dell.com/operatingsystemmanuals.
- Dell Lifecycle Controller. See the Lifecycle Controller documentation at dell.com/esmmanuals.
- Dell OpenManage Deployment Toolkit. See the OpenManage documentation at dell.com/openmanagemanuals.

For information on the list of operating systems supported on your system, see the operating systems support matrix at dell.com/ossupport.

Managing your system remotely

To perform out-of-band systems management using iDRAC, you must configure iDRAC for remote accessibility, set up the management station and managed system, and configure the supported Web browsers. For more information, see the Integrated Dell Remote Access Controller User's Guide at dell.com/esmmanuals.

You can also remotely monitor and manage the server by using the Dell OpenManage Server Administrator (OMSA) software and OpenManage Essentials (OME) systems management console. For more information, see dell.com/openmanagemanuals.

Downloading and installing drivers and firmware

It is recommended that you download and install the latest BIOS, drivers, and systems management firmware on your system.

Prerequisites

Ensure that you clear the web browser cache.

Steps

1. Go to dell.com/support/drivers.
2. In the **Product Selection** section, enter the Service Tag of your system in the **Service Tag or Express Service Code** field.



NOTE: If you do not have the Service Tag, select **Automatically detect my Service Tag for me** to allow the system to automatically detect your Service Tag, or select **Choose from a list of all Dell products** to select your product from the **Product Selection** page.

3. Click **Get drivers and downloads**.

The drivers that are applicable to your selection are displayed.

4. Download the drivers you require to a diskette drive, USB drive, CD, or DVD.

Pre-operating system management applications

The pre-operating system management applications for your PowerEdge system help you manage different settings and features of your system without booting to the operating system.

Your PowerEdge system has the following pre-operating system management applications:

- System Setup
- Boot Manager
- Dell Lifecycle Controller

Navigation keys

The navigation keys can help you access the pre-operating system management applications.

Key	Description
<Page Up>	Moves to the previous screen.
<Page Down>	Moves to the next screen.
Up arrow	Moves to the previous field.
Down arrow	Moves to the next field.
<Enter>	Enables you to type a value in the selected field (if applicable) or follow the link in the field.
Spacebar	Expands or collapses a drop-down list, if applicable.
<Tab>	Moves to the next focus area.
	 NOTE: This feature is applicable for the standard graphical browser only.
<Esc>	Moves to the previous page until you view the main screen. Pressing <Esc> in the main screen exits System BIOS/iDRAC Settings/Device Settings/Service Tag Settings and proceeds with system boot.
<F1>	Displays the System Setup help.

About System Setup

Using System Setup, you can configure the BIOS settings, iDRAC settings, and device settings of your system.

You can access System Setup in two ways:

- Standard Graphical Browser — This is enabled by default.
- Text Browser — This is enabled using Console Redirection.

 **NOTE:** By default, help text for the selected field is displayed in the graphical browser. To view the help text in the text browser, press <F1>.

Entering System Setup

1. Turn on or restart your system.
2. Press <F2> immediately after you see the following message:
<F2> = System Setup

If your operating system begins to load before you press <F2>, allow the system to finish booting, and then restart your system and try again.

System Setup Main Menu

Option	Description
System BIOS	Enables you to configure BIOS settings.
iDRAC Settings	Enables you to configure iDRAC settings. The iDRAC Settings utility is an interface to set up and configure the iDRAC parameters by using UEFI. You can enable or disable various iDRAC parameters by using the iDRAC Settings utility. For more information about this utility, see the Integrated Dell Remote Access Controller User's Guide at dell.com/esmmanuals .
Device Settings	Enables you to configure device settings.

System BIOS screen

By using the **System BIOS** screen you can view the BIOS settings as well as edit specific functions such as **Boot Order**, **System Password**, **Setup Password**, setting the RAID mode, and enabling or disabling USB ports.

In the **System Setup Main Menu**, click **System BIOS**.

Menu Item	Description
System Information	Displays information about the system such as the system model name, BIOS version and Service Tag.
Memory Settings	Displays information and options related to the installed memory.
Processor Settings	Displays information and options related to the processor such as speed, cache size, and so on.
SATA Settings	Displays options to enable or disable the integrated SATA controller and ports.
Boot Settings	Displays options to specify the boot mode (BIOS or UEFI). Enables you to modify UEFI and BIOS boot settings.
Network Settings	Displays options to change the network settings.
Integrated Devices	Displays options to enable or disable integrated device controllers and ports, and to specify related features and options.

Menu Item	Description
Serial Communication	Displays options to enable or disable the serial ports and specify related features and options.
System Profile Settings	Displays options to change the processor power management settings, memory frequency, and so on.
System Security	Displays options to configure the system security settings like, system password, setup password, TPM security, and so on. It also enables or disables support for the power and NMI buttons on the system.
Miscellaneous Settings	Displays options to change the system date, time, and so on.

System Information screen

You can use the **System Information** screen to view system properties such as Service Tag, system model, and the BIOS version.

To view the **System Information** click **System Setup Main Menu → System BIOS → System Information**.

Menu Item	Description
System Model Name	Displays the system model name.
System BIOS Version	Displays the BIOS version installed on the system.
System Management Engine Version	Displays the current revision of the Management Engine firmware.
System Service Tag	Displays the system Service Tag.
System Manufacturer	Displays the name of the system manufacturer.
System Manufacturer Contact Information	Displays the contact information of the system manufacturer.
System CPLD Version	Displays the current revision of the system CPLD firmware.
UEFI Compliance Version	Displays the system firmware UEFI compliance level.

Memory Settings screen

You can use the **Memory Settings** screen to view all the memory settings as well as enable or disable specific memory functions such as system memory testing and node interleaving.

To view the **Memory Setting** screen, click **System Setup Main Menu → System BIOS → Memory Settings**.

Menu Item	Description
System Memory Size	Displays the amount of memory installed in the system.
System Memory Type	Displays the type of memory installed in the system.
System Memory Speed	Displays the system memory speed.
System Memory Voltage	Displays the system memory voltage.
Video Memory	Displays the amount of video memory utilized.
System Memory Testing	Specifies whether system memory tests are run during system boot. Options are Enabled and Disabled . By default, the System Memory Testing option is set to Disabled .
Memory Operating Mode	Specifies the memory operating mode. The options available are Optimizer Mode , Advanced ECC Mode , Mirror Mode , Spare Mode , and



Menu Item	Description
	<p>Spare with Advanced ECC Mode. By default, the Memory Operating Mode option is set to Optimizer Mode.</p> <p> NOTE: The Memory Operating Mode can have different defaults and available options based on the memory configuration of your system.</p>
Node Interleaving	Specifies if Non-Uniform Memory architecture (NUMA) is supported. If this field is Enabled , memory interleaving is supported if a symmetric memory configuration is installed. If Disabled , the system supports NUMA (asymmetric) memory configurations. By default, Node Interleaving option is set to Disabled .
Snoop Mode	Specifies the Snoop Mode options. Snoop Mode options available are Home Snoop , Early Snoop , and Cluster on Die . By default, the Snoop Mode option is set to Early Snoop . The field is only available when Node Interleaving is Disabled .

Processor Settings screen

You can use the **Processor Settings** screen to view the processor settings and perform specific functions such as enabling virtualization technology, hardware prefetcher, and logical processor idling.

To view the **Processor Settings** screen, click **System Setup Main Menu** → **System BIOS** → **Processor Settings**.

Menu Item	Description
Logical Processor	Enables or disables the logical processors and displays the number of logical processors. If the Logical Processor option is set to Enabled , the BIOS displays all the logical processors. If this option is set to Disabled , the BIOS displays only one logical processor per core. By default, the Logical Processor option is set to Enabled .
Alternate RTID (Requestor Transaction ID) Setting	Enables you to allocate more RTIDs to the remote socket, thereby increasing cache performance between the sockets or easing work in normal mode for NUMA. By default, the Alternate RTID (Requestor Transaction ID) Setting is set to Disabled .
Virtualization Technology	Enables or disables the additional hardware capabilities provided for virtualization. By default, the Virtualization Technology option is set to Enabled .
Address Translation Service (ATS)	Defines the Address Translation Cache (ATC) for devices to cache the DMA transactions. This field provides an interface to a chipset's Address Translation and Protection Table to translate DMA addresses to host addresses. By default, the option is set to Enabled .
Adjacent Cache Line Prefetch	Optimizes the system for applications that require high utilization of sequential memory access. By default, the Adjacent Cache Line Prefetch option is set to Enabled . You can disable this option for applications that require high utilization of random memory access.
Hardware Prefetcher	Enables or disables the hardware prefetcher. By default, the Hardware Prefetcher option is set to Enabled .
DCU Streamer Prefetcher	Allows you to enable or disable the Data Cache Unit (DCU) streamer prefetcher. By default, the DCU Streamer Prefetcher option is set to Enabled .

Menu Item	Description
DCU IP Prefetcher	Enables or disables the Data Cache Unit (DCU) IP prefetcher. By default, the DCU IP Prefetcher option is set to Enabled .
Execute Disable	Enables or disables the execute disable memory protection technology. By default, the Execute Disable option is set to Enabled .
Logical Processor Idling	Enables or disables the operating system capability to put logical processors in the idling state in order to reduce power consumption. By default, the option is set to Disabled .
Configurable TDP	Allows reconfiguration of Thermal Design Power (TDP) to lower levels. TDP refers to the maximum amount of power the cooling system is required to dissipate.
X2Apic Mode	Enables or disables the X2Apic mode.
Number of Cores per Processor	Controls the number of enabled cores in each processor. By default, the Number of Cores per Processor option is set to All .
Processor 64-bit Support	Specifies if the processor(s) support 64-bit extensions.
Processor Core Speed	Displays the maximum core frequency of the processor.
Processor Bus Speed	Displays the bus speed of the processor.  NOTE: The processor bus speed option displays only when both processors are installed.
Processor 1	 NOTE: Depending on the number of installed CPUs, there may be up to two processor listings. The following settings are displayed for each processor installed in the system.
Family-Model-Stepping	Displays the family, model and stepping of the processor as defined by Intel.
Brand	Displays the brand name reported by the processor.
Level 2 Cache	Displays the total L2 cache.
Level 3 Cache	Displays the total L3 cache.
Number of Cores	Displays the number of cores per processor.

SATA Settings screen

You can use the **SATA Settings** screen to view the SATA settings of SATA devices and enable RAID on your system.

To view the **SATA Settings** screen click **System Setup Main Menu** → **System BIOS** → **SATA Settings**.

Menu Item	Description
Embedded SATA	Enables the embedded SATA to be set to Off , ATA , AHCI , or RAID modes. By default, the Embedded SATA option is set to AHCI .
Security Freeze Lock	Sends Security Freeze Lock command to the Embedded SATA drives during POST. This option is applicable only to ATA and AHCI mode.
Write Cache	Enables or disables the command for Embedded SATA drives during POST.

Menu Item	Description
Port A	Sets the drive type of the selected device. For Embedded SATA settings in ATA mode, set this field to Auto to enable BIOS support. Set it to OFF to turn off BIOS support. For AHCI mode or RAID mode, BIOS always enables support.
Model	Displays the drive model of the selected device.
Drive Type	Displays the type of drive attached to the SATA port.
Capacity	Displays the total capacity of the hard drive. The field is undefined for removable media devices such as optical drives.
Port B	Sets the drive type of the selected device. For Embedded SATA settings in ATA mode, set this field to Auto to enable BIOS support. Set it to OFF to turn off BIOS support. For AHCI mode or RAID mode, BIOS always enables support.
Model	Displays the drive model of the selected device.
Drive Type	Displays the type of drive attached to the SATA port.
Capacity	Displays the total capacity of the hard drive. The field is undefined for removable media devices such as optical drives.
Port C	Sets the drive type of the selected device. For Embedded SATA settings in ATA mode, set this field to Auto to enable BIOS support. Set it to OFF to turn off BIOS support. For AHCI mode or RAID mode, BIOS always enables support.
Model	Displays the drive model of the selected device.
Drive Type	Displays the type of drive attached to the SATA port.
Capacity	Displays the total capacity of the hard drive. The field is undefined for removable media devices such as optical drives.
Port D	Sets the drive type of the selected device. For Embedded SATA settings in ATA mode, set this field to Auto to enable BIOS support. Set it to OFF to turn off BIOS support. For AHCI mode or RAID mode, BIOS always enables support.
Model	Displays the drive model of the selected device.
Drive Type	Displays the type of drive attached to the SATA port.
Capacity	Displays the total capacity of the hard drive. The field is undefined for removable media devices such as optical drives.
Port E	Sets the drive type of the selected device. For Embedded SATA settings in ATA mode, set this field to Auto to enable BIOS support. Set it to OFF to turn off BIOS support. For AHCI mode or RAID mode, BIOS always enables support.
Model	Displays the drive model of the selected device.
Drive Type	Displays the type of drive attached to the SATA port.



Menu Item	Description
Capacity	Displays the total capacity of the hard drive. The field is undefined for removable media devices such as optical drives.
Port F	Sets the drive type of the selected device. For Embedded SATA settings in ATA mode, set this field to Auto to enable BIOS support. Set it to OFF to turn off BIOS support. For AHCI mode or RAID mode, BIOS always enables support.
Model	Displays the drive model of the selected device.
Drive Type	Displays the type of drive attached to the SATA port.
Capacity	Displays the total capacity of the hard drive. The field is undefined for removable media devices such as optical drives.
Port G	Sets the drive type of the selected device. For Embedded SATA settings in ATA mode, set this field to Auto to enable BIOS support. Set it to OFF to turn off BIOS support. For AHCI mode or RAID mode, BIOS always enables support.
Model	Displays the drive model of the selected device.
Drive Type	Displays the type of drive attached to the SATA port.
Capacity	Displays the total capacity of the hard drive. The field is undefined for removable media devices such as optical drives.
Port H	Sets the drive type of the selected device. For Embedded SATA settings in ATA mode, set this field to Auto to enable BIOS support. Set it to OFF to turn off BIOS support. For AHCI mode or RAID mode, BIOS always enables support.
Model	Displays the drive model of the selected device.
Drive Type	Displays the type of drive attached to the SATA port.
Capacity	Displays the total capacity of the hard drive. The field is undefined for removable media devices such as optical drives.
Port I	Sets the drive type of the selected device. For Embedded SATA settings in ATA mode, set this field to Auto to enable BIOS support. Set it to OFF to turn off BIOS support. For AHCI mode or RAID mode, BIOS always enables support.
Model	Displays the drive model of the selected device.
Drive Type	Displays the type of drive attached to the SATA port.
Capacity	Displays the total capacity of the hard drive. The field is undefined for removable media devices such as optical drives.
Port J	Sets the drive type of the selected device. For Embedded SATA settings in ATA mode, set this field to Auto to enable BIOS support. Set it to OFF to turn off BIOS support. For AHCI mode or RAID mode, BIOS always enables support.
Model	Displays the drive model of the selected device.

Menu Item	Description
Drive Type	Displays the type of drive attached to the SATA port.
Capacity	Displays the total capacity of the hard drive. The field is undefined for removable media devices such as optical drives.

Boot Settings screen

You can use the **Boot Settings** screen to set the Boot mode to either **BIOS** or **UEFI**. It also allows you to specify the boot order.

To view the **Boot Settings** screen click **System Setup Main Menu** → **System BIOS** → **Boot Settings**.

Menu Item	Description
Boot Mode	<p>Enables you to set the boot mode of the system.</p> <p> CAUTION: Switching the boot mode may prevent the system from booting if the operating system is not installed in the same boot mode.</p> <p> NOTE: Setting this field to UEFI disables the BIOS Boot Settings menu. Setting this field to BIOS disables the UEFI Boot Settings menu.</p> <p>If the operating system supports UEFI, you can set this option to UEFI. Setting this field to BIOS allows compatibility with non-UEFI operating systems. By default, the Boot Mode option is set to BIOS.</p>
Boot Sequence Retry	Enables or disables the Boot Sequence Retry feature. If this field is enabled and the system fails to boot, the system reattempts the boot sequence after 30 seconds. By default, the Boot Sequence Retry option is set to Enabled .
Hard-Disk Failover	Specifies which devices in the Hard-Disk Drive Sequence are attempted in the boot sequence. When the option is Disabled , only the first hard disk device in the list is attempted to boot. When set to Enabled , all hard disk devices are attempted in order, as listed in the Hard-Disk Drive Sequence . This option is not enabled for UEFI Boot Mode.
Boot Option Settings	Configures the boot sequence and the boot devices.

Network Settings screen

You can use the **Network Settings** screen to modify PXE device settings. Network Settings are only available in UEFI boot mode. BIOS does not control network settings in the BIOS boot mode. For BIOS boot mode, the network settings are handled by the network controllers option ROM.

To view the **Network Settings** click **System Setup Main Menu** → **System BIOS** → **Network Settings**.

Menu Item	Description
PXE Device n (n = 1 to 4)	Enables or disables the device. When enabled, a UEFI boot option is created for the device.
PXE Device n Settings (n = 1 to 4)	Allows you to control the configuration of the PXE device.

Integrated Devices screen details

Integrated Devices screen allows you to view and configure the settings of all integrated devices including the video controller, integrated RAID controller, and the USB ports.

In the **System Setup Main Menu**, click **System BIOS** → **Integrated Devices**.





The **Integrated Devices** screen details are explained below.

Menu Item	Description
USB 3.0 Setting	Allows you to enable or disable the USB 3.0 support. Enable this option only if your operating system supports USB 3.0. Disabling this allows devices to operate at USB 2.0 speed. USB 3.0 is disabled by default.
User Accessible USB Ports	Allows you to enable or disable the USB ports. Selecting Only Back Ports On disables the front USB ports, selecting All Ports Off disables all USB ports. The USB keyboard and mouse operates during boot process in certain operating systems. After the boot process is complete, the USB keyboard and mouse does not work if the ports are disabled.  NOTE: Selecting Only Back Ports On and All Ports Off will disable the USB management port and also restrict access to iDRAC features.
Internal USB Port	Allows you to enable or disable the internal USB port. By default, the Internal USB Port option is set to Enabled .
Embedded NIC1 and NIC2	Allows you to enable or disable the Embedded NIC1 and NIC2. If set to Disabled , the NIC may still be available for shared network access by the embedded management controller. Configure this function using the NIC management utilities of the system.
I/OAT DMA Engine	Allows you to enable or disable the I/OAT option. Enable only if the hardware and software supports the feature.
Embedded Video Controller	Allows you to enable or disable the Embedded Video Controller . By default, the embedded video controller is Enabled . If the Embedded Video Controller is the only display capability in the system (that is, no add-in graphics card is installed), then the Embedded Video Controller is automatically used as the primary display even if the Embedded Video Controller setting is Disabled .
Current State of Embedded Video Controller	Displays the current state of the Embedded Video Controller. Current State of Embedded Video Controller is a read only field, indicating the current state for the Embedded Video Controller.
SR-IOV Global Enable	Allows you to enable or disable the BIOS configuration of Single Root I/O Virtualization (SR-IOV) devices. By default, the SR-IOV Global Enable option is set to Disabled .
OS Watchdog Timer	If your system stops responding, this watchdog timer aids in the recovery of your operating system. When this field is set to Enabled , the operating system is allowed to initialize the timer. When is set to Disabled (the default), the timer will have no effect on the system.
Memory Mapped I/O above 4GB	Allows you to enable support for PCIe devices that require large amounts of memory. By default, the option is set to Enabled .
Slot Disablement	Allows you to enable or disable available PCIe slots on your system. The Slot Disablement feature controls the configuration of PCIe cards.

Menu Item	Description
	installed in the specified slot. Slot disablement must be used only when the installed peripheral card is preventing booting into the operating system or causing delays in system startup. If the slot is disabled, both the Option ROM and UEFI driver are disabled.

Serial Communication screen

You can use the **Serial Communication** screen to view the properties of the serial communication port. To view the **Serial Communication** click **System Setup Main Menu** → **System BIOS** → **Serial Communication**.



Menu Item	Description
Serial Communication	Selects serial communication devices (Serial Device 1 and Serial Device 2) in the BIOS. BIOS console redirection can also be enabled and the port address can be specified. By default, Serial Communication option is set to Auto .
Serial Port Address	<p>Enables you to set the port address for serial devices. By default, the Serial Port Address option is set to Serial Device 1=COM2, Serial Device 2=COM1</p> <p> NOTE: You can use only Serial Device 2 for the Serial Over LAN (SOL) feature. To use console redirection by SOL, configure the same port address for console redirection and the serial device.</p> <p> NOTE: Every time the system boots, the BIOS syncs the serial MUX setting saved in iDRAC. The serial MUX setting can independently be changed in iDRAC. Therefore, loading the BIOS default settings from within the BIOS setup utility may not always revert this setting to the default setting of Serial Device 1.</p>
External Serial Connector	<p>You can associate the External Serial Connector to Serial Device 1, Serial Device 2, or the Remote Access Device using this field.</p> <p> NOTE: Only Serial Device 2 can be used for (Serial Over LAN) SOL. To use console redirection by SOL, configure the same port address for console redirection and the serial device.</p> <p> NOTE: Every time the system boots, the BIOS syncs the serial MUX setting saved in iDRAC. The serial MUX setting can independently be changed in iDRAC. Therefore, loading the BIOS default settings from within the BIOS setup utility may not always revert this setting to the default setting of Serial Device 1.</p>
Failsafe Baud Rate	Displays the failsafe baud rate for console redirection. The BIOS attempts to determine the baud rate automatically. This failsafe baud rate is used only if the attempt fails, and the value must not be changed. By default, the Failsafe Baud Rate option is set to 115200 .
Remote Terminal Type	Sets the remote console terminal type. By default, the Remote Terminal Type option is set to VT 100/VT 220 .
Redirection After Boot	Enables or disables the BIOS console redirection when the operating system is loaded. By default, the Redirection After Boot option is set to Enabled .

System Profile Settings screen

You can use the **System Profile Settings** screen to enable specific system performance settings such as power management.

To view the **System Profile Settings** click **System Setup Main Menu** → **System BIOS** → **System Profile Settings**.



Menu Item	Description
System Profile	<p>Sets the system profile. If you set the System Profile option to a mode other than Custom, the BIOS automatically sets the rest of the options. You can only change the rest of the options if the mode is set to Custom. By default, the System Profile option is set to Performance Per Watt Optimized (DAPC). DAPC is Dell Active Power Controller.</p> <p> NOTE: The following parameters are available only when the System Profile is set to Custom.</p>
CPU Power Management	<p>Sets the CPU power management. By default, the CPU Power Management option is set to System DBPM (DAPC). DBPM is Demand-Based Power Management.</p>
Memory Frequency	<p>Sets the speed of the system memory. You can select Maximum Performance, Maximum Reliability, or a specific speed.</p>
Turbo Boost	<p>Enables or disables the processor to operate in turbo boost mode. By default, the Turbo Boost option is set to Enabled.</p>
Energy Efficient Turbo	<p>Enables or disables the Energy Efficient Turbo. Energy Efficient Turbo (EET) is a mode of operation where a processor's core frequency is adjusted within the turbo range based on workload.</p>
C1E	<p>Enables or disables the processor to switch to a minimum performance state when it is idle. By default, the C1E option is set to Enabled.</p>
C States	<p>Enables or disables the processor to operate in all available power states. By default, the C States option is set to Enabled.</p>
Collaborative CPU Performance Control	<p>Enables or disables the CPU power management. When set to Enabled, the CPU power management is controlled by the OS DBPM and the System DBPM (DAPC). By default, the option is set to Disabled.</p>
Memory Patrol Scrub	<p>Sets the memory patrol scrub frequency. By default, the Memory Patrol Scrub option is set to Standard.</p>
Memory Refresh Rate	<p>Sets the memory refresh rate to either 1x or 2x. By default, the Memory Refresh Rate option is set to 1x.</p>
Uncore Frequency	<p>Selects the Processor Uncore Frequency. Dynamic mode allows the processor to optimize power resources across the cores and uncore during runtime. The optimization of the uncore frequency to either save power or optimize performance is influenced by the setting of the Energy Efficiency Policy.</p>
Energy Efficient Policy	<p>Enables you to select the Energy Efficient Policy. The CPU uses the setting to manipulate the internal behavior of the processor and determines whether to target higher performance or better power savings.</p>

Menu Item	Description
Number of Turbo Boot Enabled Cores for Processor 1	 NOTE: If there are two processors installed in the system, you see an entry for Number of Turbo Boost Enabled Cores for Processor 2 . Controls the number of turbo boost enabled cores for processor 1. By default, the maximum number of cores is enabled.
Monitor/Mwait	Enables the Monitor/Mwait instructions in the processor. By default, the Monitor/Mwait option is set to Enabled for all system profiles, except Custom .  NOTE: This option can be disabled only if the C States option in Custom mode is disabled.  NOTE: When C States is enabled in Custom mode, changing the Monitor/Mwait setting does not impact system power/performance.

System Security Settings screen

You can use the **System Security** screen to perform specific functions such as setting the system password, setup password and disabling the power button.

To view the **System Security** click **System Setup Main Menu** → **System BIOS** → **System Security Settings**.

Menu Item	Description
Intel AES-NI	Improves the speed of applications by performing encryption and decryption using the Advanced Encryption Standard Instruction Set and is set to Enabled by default.
System Password	Sets the system password. This option is set to Enabled by default and is read-only if the password jumper is not installed in the system.
Setup Password	Sets the setup password. This option is read-only if the password jumper is not installed in the system.
Password Status	Locks the system password. By default, the Password Status option is set to Unlocked .
TPM Security	 NOTE: The TPM menu is available only when the TPM module is installed. Allows you to control the reporting mode of the Trusted Platform Module (TPM). By default, the TPM Security option is set to Off . You can only modify the TPM Status, TPM Activation, and Intel TXT fields if the TPM Status field is set to either On with Pre-boot Measurements or On without Pre-boot Measurements .
TPM Information	Changes the operational state of the TPM. By default, the TPM Activation option is set to No Change .
TPM Status	Displays the TPM status.
TPM Command	 CAUTION: Clearing the TPM results in the loss of all keys in the TPM. The loss of TPM keys may affect booting to the operating system. Clears all the contents of the TPM. By default, the TPM Clear option is set to No .

Menu Item	Description
Intel TXT	Enables or disables the Intel Trusted Execution Technology (TXT). To enable Intel TXT , Virtualization Technology must be enabled and TPM Security must be Enabled with Pre-boot measurements. By default, the Intel TXT option is set to Off .
Power Button	Enables or disables the power button on the front of the system. By default, the Power Button option is set to Enabled .
NMI Button	Enables or disables the NMI button on the front of the system. By default, the NMI Button option is set to Disabled .
AC Power Recovery	Sets how the system reacts after AC power is restored to the system. By default, the AC Power Recovery option is set to Last .
AC Power Recovery Delay	Sets how the system supports staggering of power up after AC power is restored to the system. By default, the AC Power Recovery Delay option is set to Immediate .
User Defined Delay (60s to 240s)	Sets the User Defined Delay when the User Defined option for AC Power Recovery Delay is selected.
UEFI Variable Access	Provides varying degrees of securing UEFI variables. When set to Standard (the default) UEFI variables are accessible in the Operating System per the UEFI specification. When set to Controlled , selected UEFI variables are protected in the environment and new UEFI boot entries are forced to be at the end of the current boot order.
Secure Boot	Enables Secure Boot, where the BIOS authenticates each pre-boot image using the certificates in the Secure Boot Policy. Secure Boot is disabled by default.
Secure Boot Policy	When Secure Boot policy is Standard , the BIOS uses the system manufacturer's key and certificates to authenticate pre-boot images. When Secure Boot policy is Custom , the BIOS uses the user-defined key and certificates. Secure Boot policy is Standard by default.
Secure Boot Policy Summary	Displays the list of certificates and hashes that secure boot uses to authenticate images.

Secure Boot Custom Policy Settings screen

Secure Boot Custom Policy Settings is displayed only when **Secure Boot Policy** is set to **Custom**. In the **System Setup Main Menu**, click **System BIOS** → **System Security** → **Secure Boot Custom Policy Settings**.

Menu Item	Description
Platform Key	Imports, exports, deletes, or restores the platform key (PK).
Key Exchange Key Database	Allows you to import, export, delete, or restore entries in the Key Exchange Key (KEK) Database.
Authorized Signature Database	Imports, exports, deletes, or restores entries in the Authorized Signature Database (db).
Forbidden Signature Database	Imports, exports, deletes, or restores entries in the Forbidden Signature Database (dbx).

Miscellaneous Settings screen

You can use the **Miscellaneous Settings** screen to perform specific functions such as updating the asset tag, and changing the system date and time.

To view the **Miscellaneous Settings** click **System Setup Main Menu** → **System BIOS** → **Miscellaneous Settings**.

Menu Item	Description
System Time	Enables you to set the time on the system.
System Date	Enables you to set the date on the system.
Asset Tag	Displays the asset tag and enables you to modify it for security and tracking purposes.
Keyboard NumLock	Enables you to set whether the system boots with the NumLock enabled or disabled. By default the Keyboard NumLock is set to On .  NOTE: This option does not apply to 84-key keyboards.
F1/F2 Prompt on Error	Enables or disables the F1/F2 prompt on error. By default, F1/F2 Prompt on Error is set to Enabled . The F1/F2 prompt also includes keyboard errors.
Load Legacy Video Option ROM	Enables you to determine whether the system BIOS loads the legacy video (INT 10H) option ROM from the video controller. Selecting Enabled in the operating system does not support UEFI video output standards. This field is only for UEFI boot mode. You cannot set this to Enabled if UEFI Secure Boot mode is enabled.

About Boot Manager

Boot Manager enables you to add, delete, and arrange boot options. You can also access System Setup and boot options without restarting the system.

Entering Boot Manager

The **Boot Manager** screen allows you to select boot options and diagnostic utilities.

1. Turn on or restart your system.
2. Press <F11> when you see the message <F11> = Boot Manager.
If your operating system begins to load before you press <F11>, allow the system to finish booting, and then restart your system and try again.

Boot Manager main menu

Menu Item	Description
Continue Normal Boot	The system attempts to boot to devices starting with the first item in the boot order. If the boot attempt fails, the system continues with the next

Menu Item	Description
	item in the boot order until the boot is successful or no more boot options are found.
One Shot Boot Menu	Takes you to the boot menu where you can select a one time boot device to boot from.
Launch System Setup	Enables you to access the System Setup.
Launch Lifecycle Controller	Exits the Boot Manager and invokes the Lifecycle Controller program.
System Utilities	Launches system utilities menu such as system diagnostics and UEFI shell.

About Dell Lifecycle Controller

Dell Lifecycle Controller allows you to perform useful tasks such as configuring BIOS and hardware settings, deploying an operating system, updating drivers, changing RAID settings, and saving hardware profiles. For more information about Dell Lifecycle Controller, see the documentation at dell.com/esmmanuals.

Changing the boot order

You may have to change the boot order if you want to boot from a USB key or an optical drive. The instructions given below may vary if you have selected **BIOS** for **Boot Mode**.

1. In the **System Setup Main Menu**, click **System BIOS** → **Boot Settings**.
2. Click **Boot Option Settings** → **Boot Sequence**.
3. Use the arrow keys to select a boot device, and use the <+> and <-> keys to move the device down or up in the order.
4. Click **Exit**, click **Yes** to save the settings on exit.

Choosing the system boot mode

System Setup enables you to specify the boot mode for installing your operating system:

- BIOS boot mode (the default) is the standard BIOS-level boot interface.
- UEFI boot mode is an enhanced 64-bit boot interface based on Unified Extensible Firmware Interface (UEFI) specifications that overlays the system BIOS.

To choose the system boot mode follow the steps below.

1. You must select the boot mode in the **Boot Mode** field of the **Boot Settings** screen of System Setup.
2. Once you specify the boot mode, the system boots in the specified boot mode, proceed to install your operating system from that mode.
3. You must boot the system in the same boot mode (BIOS or UEFI) to access the installed operating system.

 **CAUTION: Trying to boot the operating system from the other boot mode will cause the system to halt at startup.**

 **NOTE:** Operating systems must be UEFI-compatible to be installed from the UEFI boot mode. DOS and 32-bit operating systems do not support UEFI and can only be installed from the BIOS boot mode.

 **NOTE:** For the latest information on supported operating systems, go to dell.com/ossupport.

Assigning a system and setup password

Prerequisites

 **NOTE:** The password jumper enables or disables the System Password and Setup Password features. For more information about the password jumper settings, see [System board jumper settings](#).

You can assign a new **System Password** and **Setup Password** or change an existing **System Password** and **Setup Password** only when the password jumper setting is **enabled** and **Password Status** is **Unlocked**.

If the password jumper setting is disabled, the existing **System Password** and **Setup Password** are deleted and you need not provide the system password to boot the system.

About this task

To assign a **System Password** and **Setup Password**, follow the steps below:

Steps

1. To enter System Setup, press <F2> immediately after a power-on or restart.
2. From the **System Setup Main Menu**, select **System BIOS** and press <Enter>. The **System BIOS** screen is displayed.
3. On the **System BIOS** screen, select **System Security** and press <Enter>. The **System Security** screen is displayed.
4. On the **System Security** screen, verify that **Password Status** is **Unlocked**.
5. Select **System Password**, enter your system password, and press <Enter> or <Tab>. Use the following guidelines to assign the system password:
 - A password can have up to 32 characters.
 - The password can contain the numbers 0 through 9.
 - Only the following special characters are allowed: space, ("), (+), (.), (-), (.), (/), (:), (|), (\), (|), (').

A message prompts you to re-enter the system password.

6. Re-enter the system password, and click **OK**.
7. Select **Setup Password**, enter your setup password and press <Enter> or <Tab>. A message prompts you to re-enter the setup password.
8. Re-enter the setup password, and click **OK**.
9. Press <Esc> to return to the System BIOS screen. Press <Esc> again. A message prompts you to save the changes.

 **NOTE:** Password protection does not take effect until the system restarts.

Using your system password to secure your system

Prerequisites

 **NOTE:** If you have assigned a setup password, the system accepts your setup password as an alternate system password.

Steps

1. Turn on or reboot your system.
2. Type your password and press <Enter>.

Next steps

When **Password Status** is **Locked**, type the password and press <Enter> when prompted at reboot.

If an incorrect system password is entered, the system displays a message and prompts you to re-enter your password. You have three attempts to enter the correct password. After the third unsuccessful attempt, the system displays an error message that the system has halted and must be powered down.

Even after you shut down and restart the system, the error message is displayed until the correct password is entered.

 **NOTE:** You can use the **Password Status** option in conjunction with the **System Password** and **Setup Password** options to protect your system from unauthorized changes.

Deleting or changing an existing system password and setup password

Prerequisites

Ensure that the Password jumper is set to enabled and the **Password Status** is **Unlocked** before attempting to delete or change the existing System and/or Setup password. You cannot delete or change an existing System or Setup password if the **Password Status** is **Locked**.

Steps

1. To enter System Setup, press <F2> immediately after a power on or restart.
2. From the **System Setup Main Menu**, select **System BIOS** and press <Enter>. The **System BIOS** screen is displayed.
3. On the **System BIOS Screen**, select **System Security** and press <Enter>. The **System Security** screen is displayed.
4. On the **System Security** screen, verify that **Password Status** is **Unlocked**.
5. Select **System Password**, alter or delete the existing system password and press <Enter> or <Tab>.
6. Select **Setup Password**, alter or delete the existing setup password and press <Enter> or <Tab>. If you change the System and Setup password a message prompts you to re-enter the new password. If you delete the System and Setup password, a message prompts you to confirm the deletion.
7. Press <Esc> to return to the System BIOS screen. Press <Esc> again, and a message prompts you to save the changes.

Operating with a setup password enabled

If **Setup Password** is **Enabled**, enter the correct setup password before modifying most of the System Setup options.

If you do not enter the correct password in three attempts, the system displays the message
Invalid Password! Number of unsuccessful password attempts: <x> System Halted!
Must power down.

Even after you shut down and restart the system, the error message is displayed until the correct password is entered. The following options are exceptions:

- If **System Password** is not **Enabled** and is not locked through the **Password Status** option, you can assign a system password.
- You cannot disable or change an existing system password.

 **NOTE:** You can use the Password Status option in conjunction with the **Setup Password** option to protect the system password from unauthorized changes.

Embedded system management

The Dell Lifecycle Controller provides advanced embedded systems management throughout the server's lifecycle. The Lifecycle Controller can be started during the boot sequence and can function independently of the operating system.

 **NOTE:** Certain platform configurations may not support the full set of features provided by the Lifecycle Controller.

For more information about setting up the Lifecycle Controller, configuring hardware and firmware, and deploying the operating system, see the Lifecycle Controller documentation at dell.com/support/home.

iDRAC Settings utility

The iDRAC Settings utility is an interface to set up and configure the iDRAC parameters using UEFI. You can enable or disable various iDRAC parameters using the iDRAC Settings Utility.

 **NOTE:** Accessing some of the features on the iDRAC Settings utility requires the iDRAC Enterprise License upgrade.

For more information on using iDRAC, see the iDRAC User's Guide at dell.com/esmanuals.

Entering the iDRAC Settings utility

1. Turn on or restart the managed system.
2. Press <F2> during Power-on Self-test (POST).
3. In the System Setup Main Menu page, click **iDRAC Settings**.
The iDRAC Settings screen is displayed.

Changing the Thermal Settings

The iDRAC Settings utility enables you to select and customize the thermal control settings for your system.







1. Enter the iDRAC Settings utility.
2. Under **iDRAC Settings** → **Thermal** → **User Option**, select between the following options:
 - Default
 - Maximum Exhaust Temperature
 - Fan Speed Offset

 **NOTE:** When the **User Option** is set to the default **Auto** setting, the user option cannot be modified.

3. Set the **Maximum Air Exhaust Temperature** or the **Fan Speed Offset** fields.
4. Click **Back** → **Finish** → **Yes**.

Installing and removing system components

Safety instructions

-  **WARNING:** Whenever you need to lift the system, get others to assist you. To avoid injury, do not attempt to lift the system by yourself.
-  **WARNING:** Opening or removing the system cover while the system is powered on may expose you to a risk of electric shock.
-  **CAUTION:** Do not operate the system without the cover for a duration exceeding five minutes.
-  **CAUTION:** Many repairs may only be done by a certified service technician. You should only perform troubleshooting and simple repairs as authorized in your product documentation, or as directed by the online or telephone service and support team. Damage due to servicing that is not authorized by Dell is not covered by your warranty. Read and follow the safety instructions that came with the product.
-  **NOTE:** It is recommended that you always use a static mat and static strap while working on components inside the system.
-  **NOTE:** To ensure proper operation and cooling, all bays in the system must be populated at all times with either a module or with a blank.

Before working inside your system

1. Power off the system and any attached peripherals.
2. Disconnect the system from the electrical outlet and disconnect the peripherals.
3. If installed, remove the optional front bezel.
4. Lay the system on its side.
5. Remove the system cover.

Related Links

- [Removing the front bezel](#)
- [Removing the system cover](#)

After working inside your system

1. Install the system cover.
2. Place the system upright on its feet on a flat and stable surface.
3. Install the optional bezel.

4. Reconnect the system to an electrical outlet and peripherals.
5. Power on the system, including any attached peripherals.

Related Links

[Installing the system cover](#)

[Installing the front bezel](#)

Recommended tools

You will need the #2 Phillips screwdriver to perform the removal and installation procedures.

Front bezel (optional)

Installing the front bezel

1. Locate and remove the bezel keys.
 -  **NOTE:** There are two bezel keys attached to the bezel.
2. Insert the bezel tabs into the bezel tab slots in the chassis.
3. Insert the bezel tabs into the slots on the chassis.
4. Push the top end of the bezel toward the system until the bezel locks into place.
5. Lock the bezel.

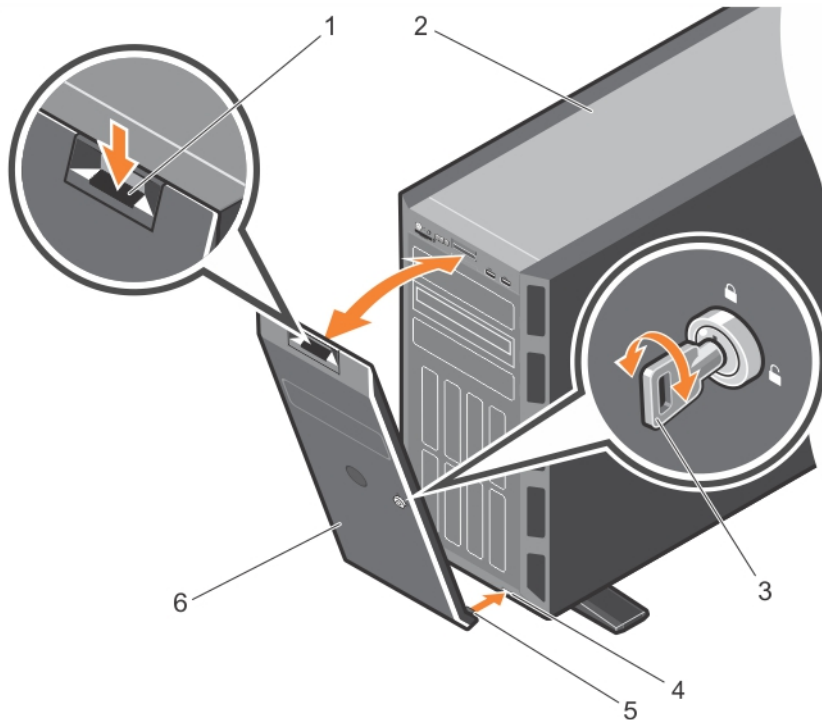

Figure 10. Installing and removing the front bezel

1. release latch

2. system

3. bezel key
4. slot on the chassis (2)
5. bezel tab (2)
6. bezel

Removing the front bezel

1. Unlock the bezel using the bezel keys.
2. Press the release latch at the top of the bezel.
3. Pull the top end of the bezel away from the system.
4. Remove the bezel by unhooking the bezel tabs from the slots at the bottom of the system.

System feet

The system feet provide stability to the system in the tower mode.

Removing the system feet

Prerequisites

 **NOTE:** It is recommended that you remove the system feet only when you are converting the system from the tower mode to the rack mode, or when you are replacing the system feet with the wheel assembly.

1. Ensure that you read the [Safety instructions](#).
2. Keep the #2 Phillips screwdriver ready.
3. Turn the system feet inward.
4. Lay the system on its side on a flat and stable surface.

Steps

Remove the screws securing the system feet to the base of the tower.

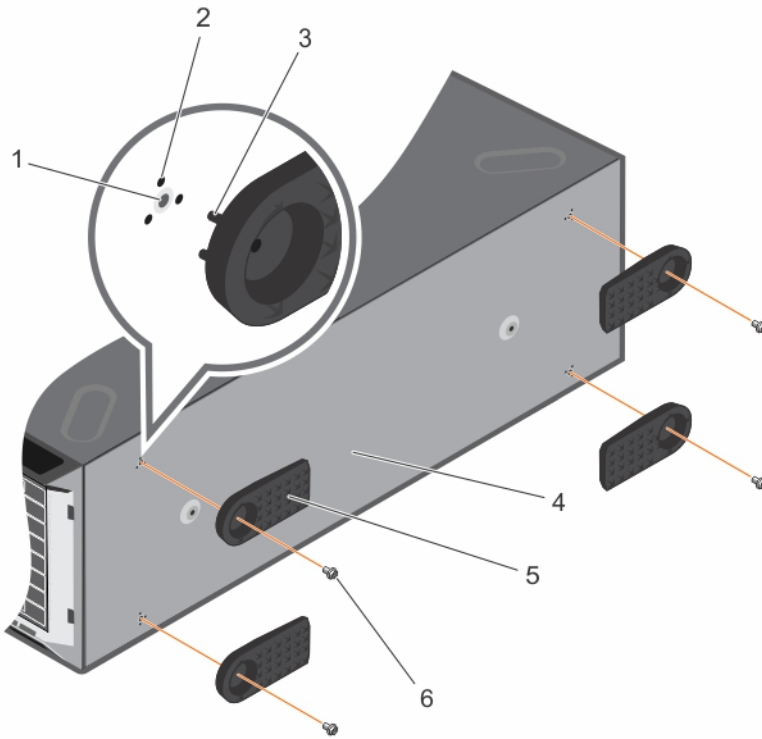

Figure 11. Removing and installing the system feet

- | | |
|--------------------|----------------------|
| 1. screw (4) | 2. slot (12) |
| 3. tab (12) | 4. base of the tower |
| 5. system feet (4) | 6. screw (4) |

Related Links

[Installing the system feet](#)

Installing the system feet

Prerequisites

⚠ CAUTION: Installing the feet on a stand-alone tower system is necessary to provide a stable foundation for the system. Failure to install the feet poses the risk of having the system tip over, possibly causing bodily injury or damage to the system.

1. Ensure that you read the [Safety instructions](#).
2. Keep the #2 Phillips screwdriver ready.
3. Lay the system on its side on a flat and stable surface.

Steps

1. Align the three tabs on the system feet with the three slots on the base of the chassis.
2. Secure the system feet to the base of the chassis by using the screws.

Next steps

Place the system upright on a flat and stable surface, and turn the system feet outward.

Related Links

[Removing the system feet](#)

Caster wheels (optional)—tower mode

Caster wheels provide mobility to the system in the tower mode.

The caster wheel assembly consists of:

- Caster wheel units (front and back)
- Two screws for the caster wheel units

Installing caster wheels

Prerequisites

1. Ensure that you read the [Safety instructions](#).
2. Keep the #2 Phillips screwdriver ready.
3. Lay the system on its side on a flat and stable surface with the base of the system extending off the edge of the surface.
4. If installed, remove the system feet.

Steps

1. Align the two retention hooks on the back wheel unit with the two slots on the base of the chassis, and insert the hooks into the slots.
2. Offset the back wheel to the back of the system and secure the unit in place using a single screw.
3. Align the two retention hooks on the front wheel with the two slots on the base of the chassis and insert the hooks into the slots.
4. Offset the front wheel to the front and secure the unit in place using a screw.

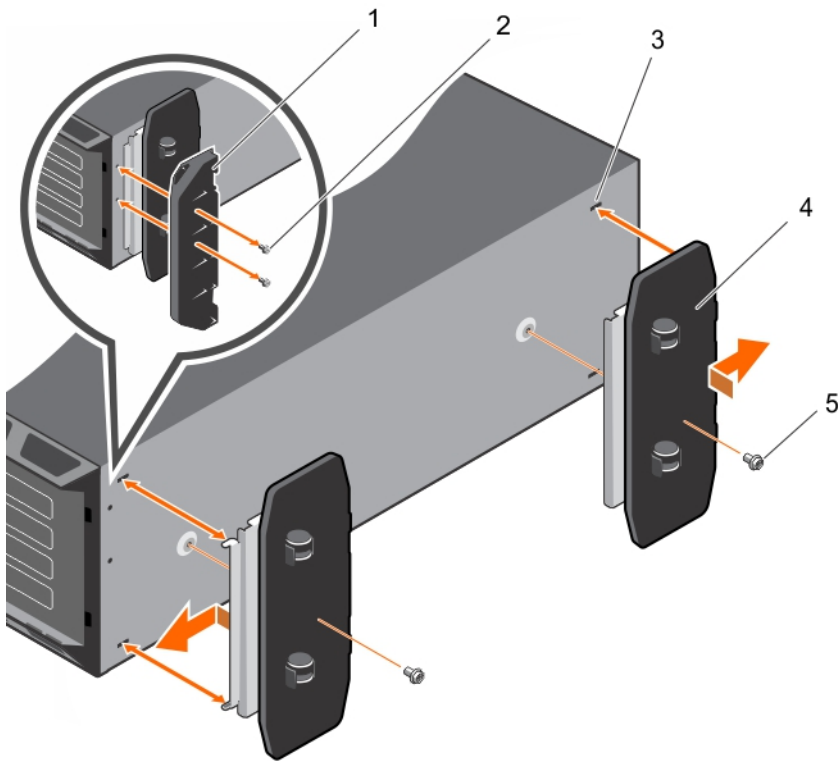

Figure 12. Removing and installing castor wheels

- | | |
|----------------------------------|-------------------------------|
| 1. support unit | 2. screw for support unit (2) |
| 3. slot on base of the tower (4) | 4. wheel assembly unit (2) |
| 5. screw for wheel assembly (2) | |

Related Links

- [Removing the system feet](#)
- [Removing castor wheels](#)

Removing castor wheels

Prerequisites

1. Ensure that you read the [Safety instructions](#).
2. Keep the #2 Phillips screwdriver ready.
3. Lay the system on a flat and stable surface with the wheels extending beyond the edge of the surface.

Steps

1. Remove the screw securing the front wheel unit to the base of the chassis.
2. Offset the front wheel unit slightly to the back of the system to release the retention hooks, and pull out the front wheel unit.
3. Remove the screw securing the back wheel unit to the base of the chassis.
4. Offset the back wheel unit slightly to the front of the system to release the retention hooks, and pull out the back wheel unit.

Related Links

[Installing caster wheels](#)

Removing the system cover

Prerequisites

1. Ensure that you read the [Safety instructions](#).
2. Power off the system, including any attached peripherals.
3. Disconnect the system from the electrical outlet and disconnect the peripherals.
4. Remove the optional front bezel.
5. Lay the system on a flat and stable surface.

Steps

1. Turn the latch release lock to the unlock position.
2. Press the cover release latch and remove the system cover.

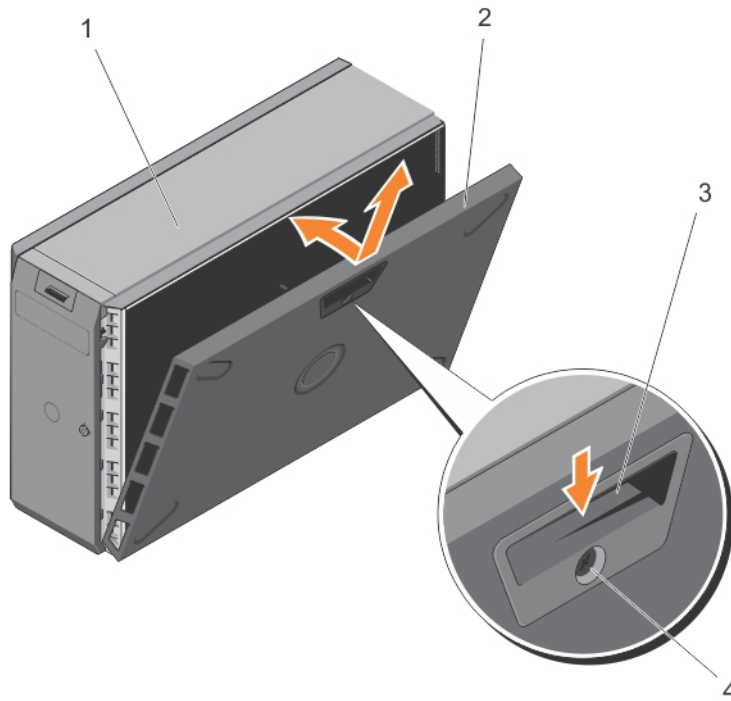

Figure 13. Removing and installing the system cover

- | | |
|------------------------|-----------------------------|
| 1. system | 2. system cover |
| 3. cover release latch | 4. cover release latch lock |

Related Links

[Removing the front bezel](#)

[Installing the system cover](#)

Installing the system cover

Prerequisites

Ensure that you read the [Safety instructions](#).

Steps

1. Align the slots on the system cover with the tabs on the chassis.
2. Press the cover release latch, and push the cover toward the chassis until the latch locks into place.
3. Turn the latch release lock to the locked position.

Next steps

1. Place the system upright on its feet on a flat and stable surface.
2. If removed, install the front bezel.
3. Reconnect the system to its electrical outlet.
4. Power on the system, and reconnect any attached peripherals.

Related Links

[Installing the front bezel](#)

[Removing the system cover](#)

Inside the system



CAUTION: Many repairs may only be done by a certified service technician. You should only perform troubleshooting and simple repairs as authorized in your product documentation, or as directed by the online or telephone service and support team. Damage due to servicing that is not authorized by Dell is not covered by your warranty. Read and follow the safety instructions that came with the product.



NOTE: Components that are hot-swappable are marked orange and touch-points on the components are marked blue.

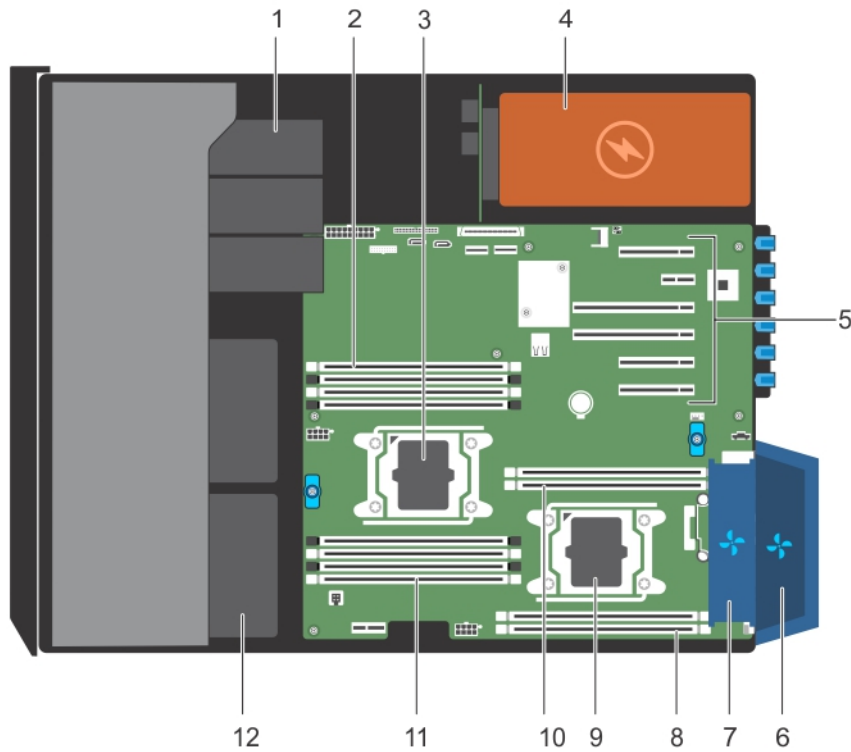

Figure 14. Inside the system

- | | |
|--------------------------------|------------------------------------|
| 1. optical drive or tape drive | 2. memory-module slots (4) |
| 3. processor 1 | 4. power supply unit |
| 5. expansion card slots | 6. external cooling fan (optional) |
| 7. internal cooling fan | 8. memory-module slots (2) |
| 9. processor 2 | 10. memory-module slots (2) |
| 11. memory-module slots (4) | 12. hard drives |

Optical drives and tape drives (optional)

Your system supports one of the following configurations:

- Systems with cabled hard drives support one optical drive and one tape drive.
- Systems with hot-swappable hard drives support up to one optical drive and two tape drives.
 - ▣ **NOTE:** If your system is installed with a double-width GPU card, the system supports only one 5.25 inch removal media storage.
 - ▣ **NOTE:** You can also install a Dell PowerVault RD1000 removable media device on your system.

For systems with hot-swappable hard drives, the optical and tape drives can be configured as follows:

Slot 1	SATA optical drive or PowerVault RD1000
Slot 2	PowerVault RD1000 or blank
Slot 3	SAS tape drive or blank



Removing the optical drive or tape drive

Prerequisites

 **CAUTION:** Many repairs may only be done by a certified service technician. You should only perform troubleshooting and simple repairs as authorized in your product documentation, or as directed by the online or telephone service and support team. Damage due to servicing that is not authorized by Dell is not covered by your warranty. Read and follow the safety instructions that came with the product.

1. Ensure that you read the [Safety instructions](#).
2. Follow the procedure listed in [Before working inside your system](#).

Steps

1. Disconnect the power and data cables from the back of the optical/tape drive.
 -  **NOTE:** Observe the routing of the power and data cable inside the chassis when you remove them from the system board and the optical/tape drive. You must route these cables correctly and in a similar manner when you replace them to prevent them from being pinched or crimped.
2. To remove the optical/tape drive, push the release latch as indicated in the figure.
3. Slide the optical/tape drive out of the drive bay.
4. If you are not immediately replacing the optical/tape drive, install the optical/tape drive blank.
 -  **NOTE:** Blanks must be installed on empty optical drive or tape drive slots to maintain FCC certification of the system. The brackets also keep dust and dirt out of the system and aid in proper cooling and airflow inside the system.
 -  **NOTE:** The procedure to install an optical/tape drive blank is similar to the procedure to install an optical/tape drive.

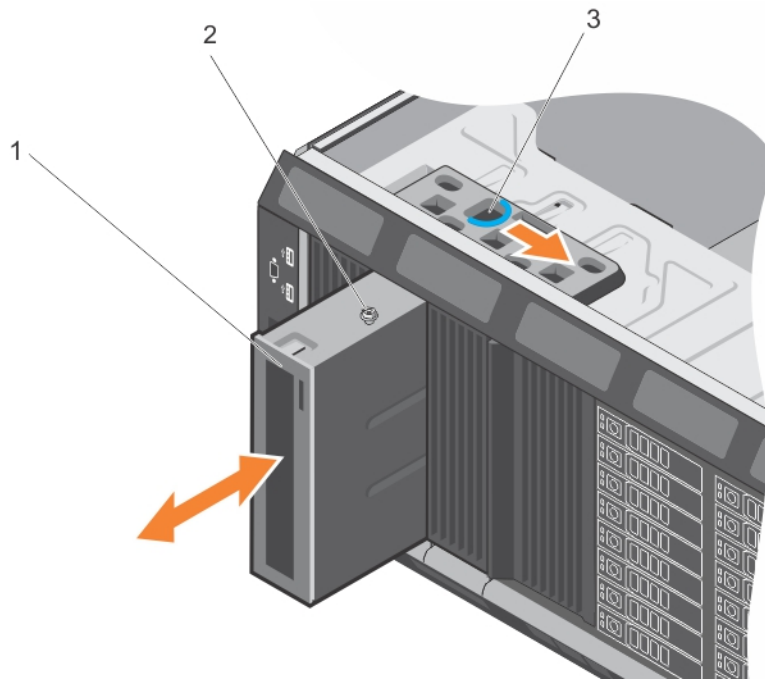



Figure 15. Removing and installing the optical drive or tape drive

1. optical drive/tape drive
2. guide
3. release latch

 **NOTE:** The following figure shows the cabling diagram for an optical drive/tape drive with an x16 backplane. All backplanes have an ODD connector.

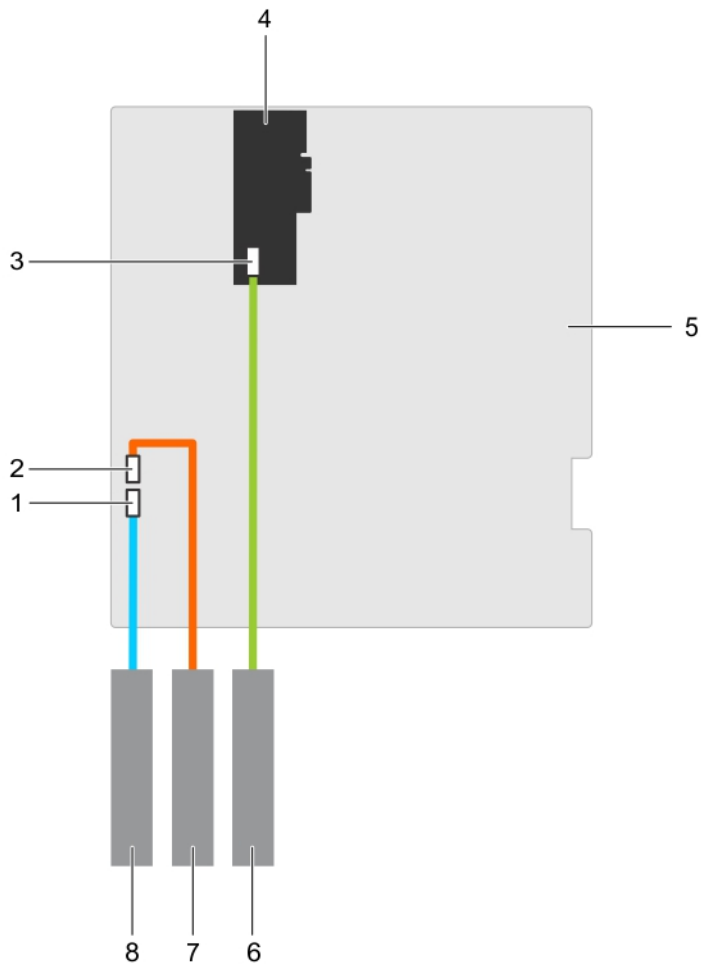

Figure 16. Cabling— optical drive and tape drive

- | | |
|--|---|
| 1. optical drive connector on system board | 2. tape drive connector on system board |
| 3. SAS tape drive connector on the PERC card | 4. PERC card |
| 5. system board | 6. SAS tape drive |
| 7. tape drive | 8. optical drive |

Related Links

[Installing the optical drive or tape drive](#)

Installing the optical drive or tape drive

Prerequisites

 **CAUTION:** Many repairs may only be done by a certified service technician. You should only perform troubleshooting and simple repairs as authorized in your product documentation, or as directed by the online or telephone service and support team. Damage due to servicing that is not authorized by Dell is not covered by your warranty. Read and follow the safety instructions that came with the product.

1. Ensure that you read the [Safety instructions](#).
2. Follow the procedure listed in [Before working inside your system](#).

Steps

1. Unpack and prepare the drive for installation.
For instructions, see the documentation that accompanied the drive.

If you are installing a SAS tape drive, you must have an internal tape adapter installed. For more information on installing a SAS tape drive, see [Installing an expansion card](#).

2. If installed, remove the old drive or the drive blank.
3. Align the guide on the drive with the slot on drive bay.
4. Slide the optical/tape drive into the slot until the optical/tape drive snaps into place.
5. Connect the power cable and data cables to the back of the optical/tape drive.
6. Connect the power cable to the backplane and the and data cable to the system board.
You can connect up to one optical drive with one SATA tape backup unit, and one SAS tape backup unit using Dell OpenManage IT Assistant.

Next steps

Follow the procedure listed in [After working inside your system](#).

Related Links

[Removing the optical drive or tape drive](#)

Cooling shroud

Removing the cooling shroud

Prerequisites

 **CAUTION:** Many repairs may only be done by a certified service technician. You should only perform troubleshooting and simple repairs as authorized in your product documentation, or as directed by the online or telephone service and support team. Damage due to servicing that is not authorized by Dell is not covered by your warranty. Read and follow the safety instructions that came with the product.

 **CAUTION:** Never operate your system with the cooling shroud removed. The system may get overheated quickly, resulting in shutdown of the system and loss of data.

1. Ensure that you read the [Safety instructions](#).
2. Follow the procedure listed in [Before working inside your system](#).

Steps

Holding the touch points, lift the cooling shroud from the system.

 **NOTE:** Systems with x16 hard-drive backplanes use a different cooling shroud. To ensure proper cooling, always install the cooling shroud provided with your system.

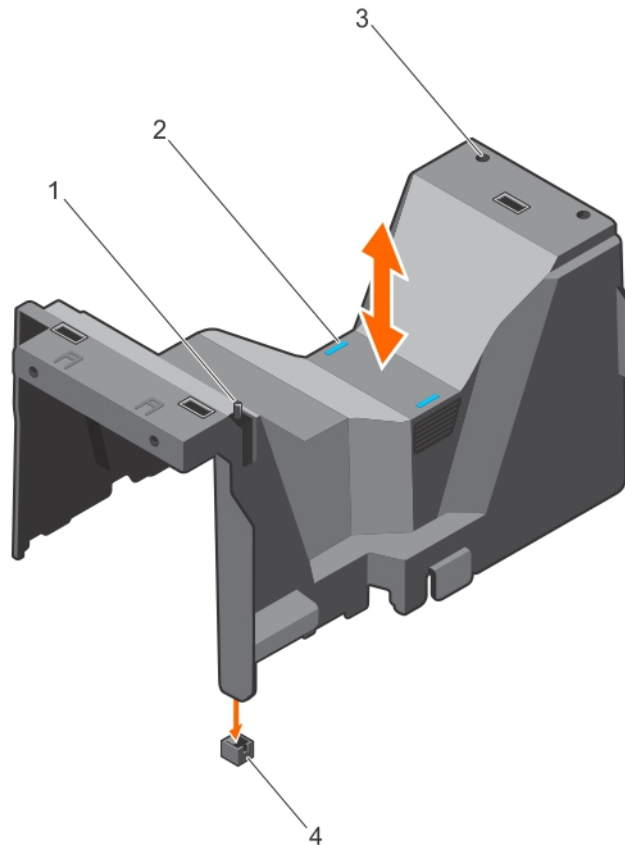

Figure 17. Removing and installing the cooling shroud — 3.5 inch hard-drive system

- | | |
|-----------------------------|---|
| 1. chassis intrusion switch | 2. touch points (2) |
| 3. slots (2) | 4. chassis intrusion-switch connector on the system board |

Related Links

[Installing the cooling shroud](#)

Installing the cooling shroud

Prerequisites

 **CAUTION:** Many repairs may only be done by a certified service technician. You should only perform troubleshooting and simple repairs as authorized in your product documentation, or as directed by the online or telephone service and support team. Damage due to servicing that is not authorized by Dell is not covered by your warranty. Read and follow the safety instructions that came with the product.

Ensure that you read the [Safety instructions](#).

 **CAUTION: Do not operate the system with the cover removed for a duration exceeding 5 minutes.**

 **NOTE:** For proper seating of the cooling shroud in the system chassis, ensure that the cables inside the system are routed along the chassis wall and secured using the cable securing clips.

Steps

1. Align the two slots on the cooling shroud with the tabs on the internal cooling fan.
2. Lower the cooling shroud into the chassis until the two slots on the cooling shroud are flush with the tabs on the internal cooling fan.

 **NOTE:** When the cooling shroud is properly seated, the chassis intrusion-switch on the cooling shroud connects to the chassis intrusion-switch connector on the system board.

Related Links

[Removing the cooling shroud](#)

Hot-swappable hard drives

Your system supports Entry Hard Drives and Enterprise Class Hard Drives. Entry Hard Drives are designed for 5x8 operating environment with less workload rating to drives and Enterprise Class Drives are designed for 24x7 operating environment. Selecting the correct drive class will enable the critical areas of quality, functionality, performance, and reliability to be optimized for the target implementation.

 **NOTE:** Do not mix Enterprise Class Drives with Entry Hard Drives.

For more information on these hard drives, see the *512e and 4Kn Disk Formats* whitepaper and *4K Sector HDD FAQ* document at dell.com/poweredge/manuals.

Choosing the right drive type depends on the usage pattern. Improper use of Entry Hard Drives (workload rating exceed 55TB/year) will lead to significant risk and increase the drives failure rate.

All hard drives connect to the system board through the hard-drive backplane. Hard drives are supplied in hot-swappable hard-drive carriers that fit in the hard-drive slots.

 **CAUTION: Before attempting to remove or install a hard drive while the system is running, see the documentation for the storage controller card to ensure that the host adapter is configured correctly to support hot-swap hard drive removal and insertion.**

 **CAUTION: Do not turn off or restart your system while the hard drive is being formatted. Doing so can cause a hard drive failure.**

Use only hard drives that have been tested and approved for use with the hard-drive backplane.

When you format a hard drive, allow enough time for the formatting to be completed. Be aware that high-capacity hard drives can take a number of hours to format.

Removing a hot-swap hard drive

Prerequisites

CAUTION: Many repairs may only be done by a certified service technician. You should only perform troubleshooting and simple repairs as authorized in your product documentation, or as directed by the online or telephone service and support team. Damage due to servicing that is not authorized by Dell is not covered by your warranty. Read and follow the safety instructions that came with the product.

1. Ensure that you read the [Safety instructions](#).
2. If installed, remove the front bezel.
3. Using the management software, prepare the hard drive for removal. For more information, see the documentation for the storage controller.

If the hard drive is online, the green activity/fault indicator flashes as the drive is turned off. You can remove the hard-drive when the hard-drive indicators turn off.

CAUTION: To prevent data loss, ensure that your operating system supports hot-swap drive installation. See the documentation supplied with your operating system.

Steps

1. Press the release button to open the hard-drive carrier release handle.
2. Slide the hard-drive carrier out of the hard-drive slot.

CAUTION: To maintain proper system cooling, all empty hard-drive slots must have hard-drive blanks installed.

3. If you are not replacing the hard drive immediately, insert a hard-drive blank in the empty hard-drive slot.

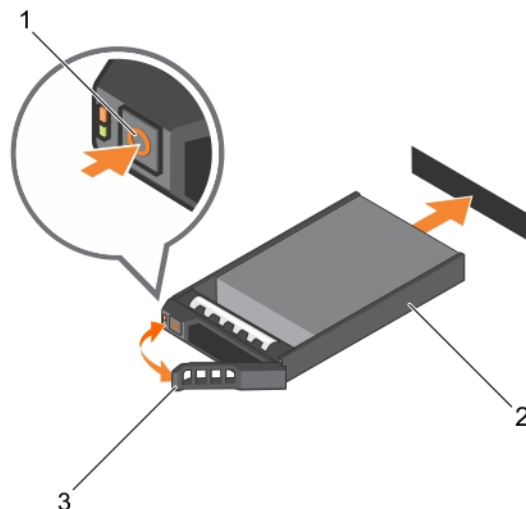

Figure 18. Removing and installing a hot-swap hard drive







1. release button
2. hard-drive carrier
3. hard-drive carrier handle

Next steps

If removed, install the front bezel.

Installing a hot-swap hard drive

Prerequisites

-  **CAUTION:** Many repairs may only be done by a certified service technician. You should only perform troubleshooting and simple repairs as authorized in your product documentation, or as directed by the online or telephone service and support team. Damage due to servicing that is not authorized by Dell is not covered by your warranty. Read and follow the safety instructions that came with the product.
-  **CAUTION:** Use only hard drives that have been tested and approved for use with the hard-drive backplane.
-  **CAUTION:** Combining SAS and SATA hard drives in the same RAID volume is not supported.
-  **CAUTION:** When installing a hard drive, ensure that the adjacent drives are fully installed. Inserting a hard-drive carrier and attempting to lock its handle next to a partially installed carrier can damage the partially installed carrier's shield spring and make it unusable.
-  **CAUTION:** To prevent data loss, ensure that your operating system supports hot-swap drive installation. See the documentation supplied with your operating system.
-  **CAUTION:** When a replacement hot-swappable hard drive is installed and the system is powered on, the hard drive automatically begins to rebuild. Make absolutely sure that the replacement hard drive is blank or contains data that you wish to have over-written. Any data on the replacement hard drive is immediately lost after the hard drive is installed.

Steps



1. If a hard-drive blank is installed in the hard-drive slot, remove it.
2. Install a hard drive in the hard-drive carrier.
3. Press the release button on the front of the hard-drive carrier and open the hard-drive carrier handle.
4. Insert the hard-drive carrier into the hard-drive slot until the carrier comes in contact with the backplane.
5. Close the hard-drive carrier handle to lock the hard drive in place.

Next steps

If applicable, install the front bezel.

Removing a hard-drive blank

Prerequisites

-  **CAUTION:** Many repairs may only be done by a certified service technician. You should only perform troubleshooting and simple repairs as authorized in your product documentation, or as directed by the online or telephone service and support team. Damage due to servicing that is not authorized by Dell is not covered by your warranty. Read and follow the safety instructions that came with the product.
 -  **CAUTION:** To maintain proper system cooling, all empty hard-drive slots must have hard-drive blanks installed.
1. Ensure that you read the [Safety instructions](#).
 2. If installed, remove the bezel.

Steps

Press the release button and slide the hard-drive blank out of the hard-drive slot.

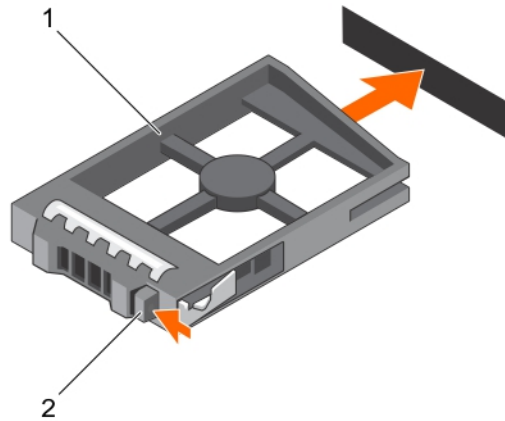

Figure 19. Removing and installing a 2.5 inch hard-drive blank

1. hard-drive blank

2. release button

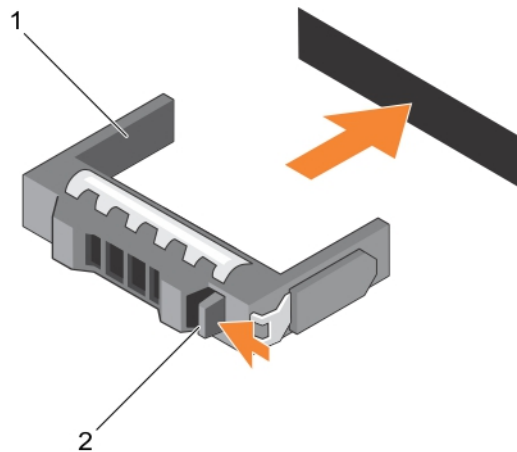

Figure 20. Removing and installing a 3.5 inch hard-drive blank

1. hard-drive blank

2. release button

Installing a hard-drive blank

Prerequisites

1. Ensure that you read the [Safety instructions](#).
2. If installed, remove the front bezel.

Steps

Insert the hard-drive blank into the hard-drive slot until the release button clicks into place.

Next steps

If applicable, install the front bezel.

Installing a 2.5 inch hard drive into a 3.5 inch hard-drive adapter

Prerequisites

⚠ CAUTION: Many repairs may only be done by a certified service technician. You should only perform troubleshooting and simple repairs as authorized in your product documentation, or as directed by the online or telephone service and support team. Damage due to servicing that is not authorized by Dell is not covered by your warranty. Read and follow the safety instructions that came with the product.

1. Ensure that you read the [Safety instructions](#).
2. Keep the #2 Phillips screwdriver ready.

Steps

1. Align the screw holes on the 2.5 inch hard drive with the screw holes on the 3.5 inch hard-drive adapter.
2. Install the screws to secure the hard drive to the hard-drive adapter.

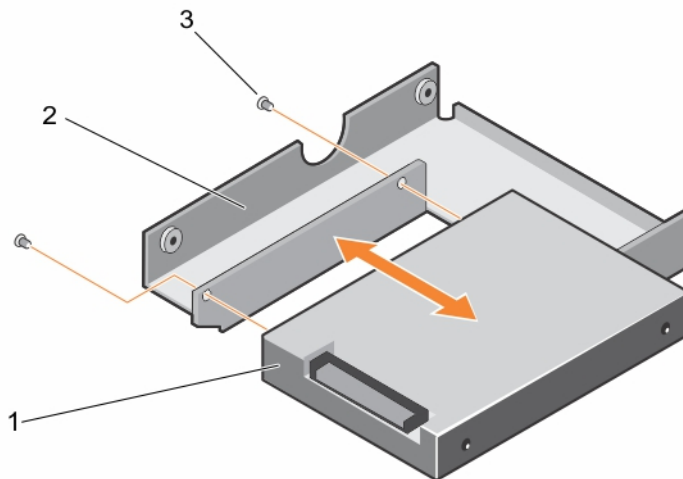



Figure 21. Removing and installing a 2.5 inch hard drive into a 3.5 inch hard-drive adapter

1. 2.5 inch hard drive
2. 3.5 inch hard-drive adapter
3. screw (2)

Removing a 2.5 inch hard drive from a 3.5 inch hard-drive adapter

Prerequisites

 **CAUTION:** Many repairs may only be done by a certified service technician. You should only perform troubleshooting and simple repairs as authorized in your product documentation, or as directed by the online or telephone service and support team. Damage due to servicing that is not authorized by Dell is not covered by your warranty. Read and follow the safety instructions that came with the product.

1. Ensure that you read the [Safety instructions](#).
2. Keep the #2 Phillips screwdriver ready.

 **NOTE:** A 2.5 inch hard drive is installed in a 3.5 inch hard-drive adapter, which is then installed in the 3.5 inch hard-drive carrier.

Steps

1. Remove the screws from the side of the 3.5 inch hard-drive adapter.
2. Remove the hard drive from the hard-drive adapter.

Installing a hard-drive adapter into a hard-drive carrier

Prerequisites

 **CAUTION:** Many repairs may only be done by a certified service technician. You should only perform troubleshooting and simple repairs as authorized in your product documentation, or as directed by the online or telephone service and support team. Damage due to servicing that is not authorized by Dell is not covered by your warranty. Read and follow the safety instructions that came with the product.

1. Ensure that you read the [Safety instructions](#).
2. Keep the #2 Phillips screwdriver ready.

Steps

1. Insert the hard-drive adapter into the hard-drive carrier with the connector end of the hard drive toward the back of the hard-drive carrier.
2. Align the screw holes on the hard drive with the holes on the hard-drive carrier.
3. Install the screws to secure the hard drive to the hard-drive carrier.

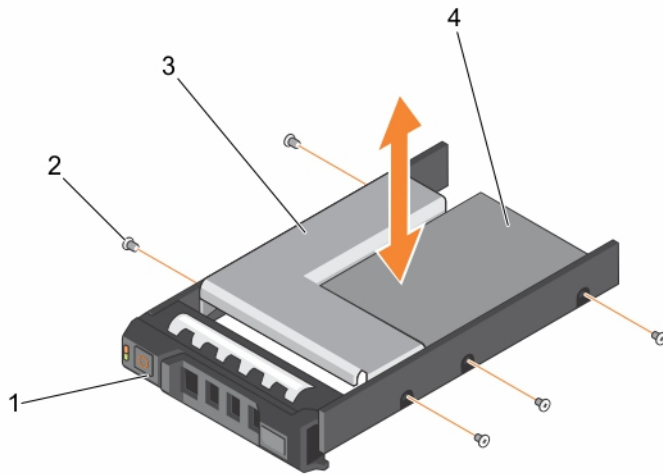

Figure 22. Removing and installing a hard-drive adapter into a 3.5 inch hard-drive carrier

- | | |
|--------------------------------|------------------------|
| 1. 3.5 inch hard-drive carrier | 2. screw (5) |
| 3. hard-drive adapter | 4. 2.5 inch hard drive |

Removing a hard-drive adapter from a hard-drive carrier

Prerequisites

1. Ensure that you read the [Safety instructions](#).
2. Keep the #2 Phillips screwdriver ready.

Steps

1. Remove the screws from the slide rails on the hard-drive carrier.
2. Lift the hard-drive adapter out of the hard-drive carrier.

Removing a hard drive from a hard-drive carrier

Prerequisites

1. Keep the #2 Phillips screwdriver ready.
2. Remove the hard-drive carrier from the system.

Steps

1. Remove the screws from the slide rails on the hard-drive carrier.
2. Lift the hard drive out of the hard-drive carrier.

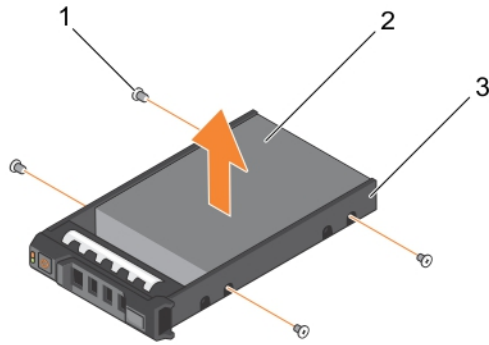

Figure 23. Removing and installing a hard drive into a hard-drive carrier

1. screw (4)
2. hard drive
3. hard-drive carrier

Installing a hard drive into a hard-drive carrier

Prerequisites

⚠ CAUTION: Many repairs may only be done by a certified service technician. You should only perform troubleshooting and simple repairs as authorized in your product documentation, or as directed by the online or telephone service and support team. Damage due to servicing that is not authorized by Dell is not covered by your warranty. Read and follow the safety instructions that came with the product.

Keep the #2 Phillips screwdriver ready.

Steps

1. Insert the hard drive into the hard-drive carrier with the connector end of the hard drive toward the back of the hard-drive carrier.
2. Align the screw holes on the hard drive with the screw holes on the hard-drive carrier.
When aligned correctly, the back of the hard drive is flush with the back of the hard-drive carrier.
3. Attach the screws to secure the hard drive to the hard-drive carrier.

Cabled hard drives

Your system supports up to four 3.5 inch (SAS or SATA) cabled hard drives. Cabled hard drives are installed in an internal hard-drive bay.

⚠ CAUTION: Do not turn off or restart your system while the hard drive is being formatted. Doing so can cause a hard drive failure.

📝 NOTE: Use only hard drives that have been tested and approved for use with your system.

Removing the internal hard-drive bay

Prerequisites

⚠ CAUTION: Many repairs may only be done by a certified service technician. You should only perform troubleshooting and simple repairs as authorized in your product documentation, or as directed by the online or telephone service and support team. Damage due to servicing that is not authorized by Dell is not covered by your warranty. Read and follow the safety instructions that came with the product.

1. Ensure that you read the [Safety instructions](#).
2. Keep the #2 Phillips screwdriver ready.
3. Follow the procedure listed in [Before working inside your system](#).

Steps

1. Disconnect the data and power cable(s) from the hard drive(s).
2. Loosen the two captive screws securing the internal hard-drive bay to the chassis.
3. Lift the internal hard-drive bay up and out of the chassis.

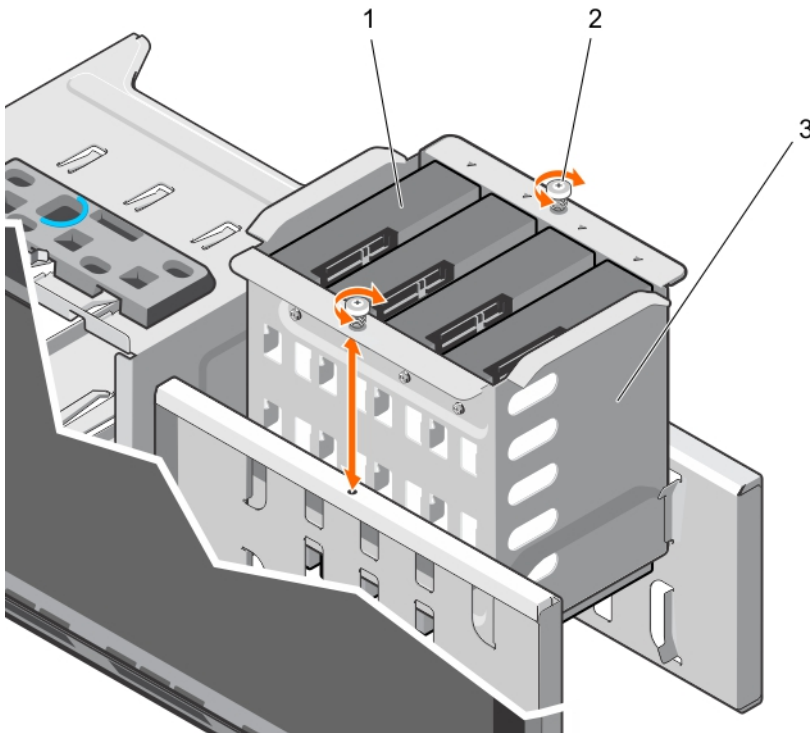

Figure 24. Installing and removing the internal hard-drive bay

- | | |
|----------------------------|-----------------------|
| 1. cabled hard drives (4) | 2. captive screws (2) |
| 3. internal hard-drive bay | |

Related Links

[Installing the internal hard-drive bay](#)

Installing the internal hard-drive bay

Prerequisites

 **CAUTION:** Many repairs may only be done by a certified service technician. You should only perform troubleshooting and simple repairs as authorized in your product documentation, or as directed by the online or telephone service and support team. Damage due to servicing that is not authorized by Dell is not covered by your warranty. Read and follow the safety instructions that came with the product.

1. Ensure that you read the [Safety instructions](#).
2. Keep the #2 Phillips screwdriver ready.

Steps

1. Align the internal hard-drive bay with the tabs on the chassis and slide the internal hard-drive bay into the chassis.
2. Secure the internal hard-drive bay to the chassis using the two captive screws.
3. Connect the data and power cables to the hard drive(s).

Next steps

Follow the procedure listed in [After working inside your system](#).

Related Links

[Removing the internal hard-drive bay](#)

Removing a cabled hard drive

Prerequisites

 **CAUTION:** Many repairs may only be done by a certified service technician. You should only perform troubleshooting and simple repairs as authorized in your product documentation, or as directed by the online or telephone service and support team. Damage due to servicing that is not authorized by Dell is not covered by your warranty. Read and follow the safety instructions that came with the product.

1. Ensure that you read the [Safety instructions](#).
2. Keep the #2 Phillips screwdriver ready.
3. Follow the procedure listed in [Before working inside your system](#).

Steps

1. Remove the power and data cables from the hard drive(s) in the internal hard-drive bay.
2. Remove the internal hard-drive bay.
3. Remove the four screws securing the hard drive to the internal hard-drive bay.
4. Remove the hard drive from the internal hard-drive bay.

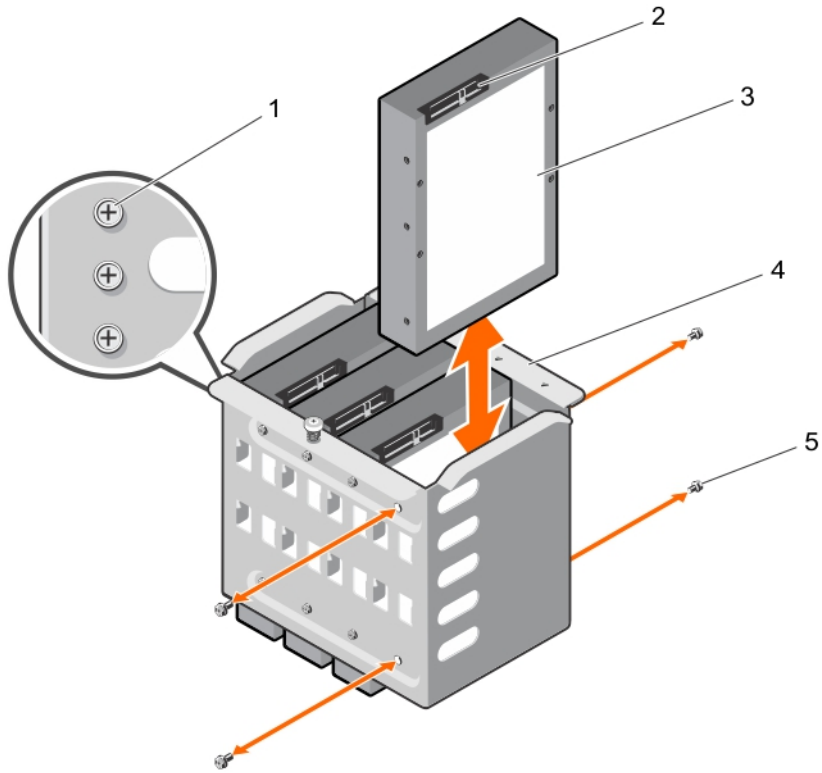

Figure 25. Removing and installing a cabled hard drive

- | | |
|-----------------|----------------------------|
| 1. spare screws | 2. hard drive connector |
| 3. hard drive | 4. internal hard-drive bay |
| 5. screws (4) | |

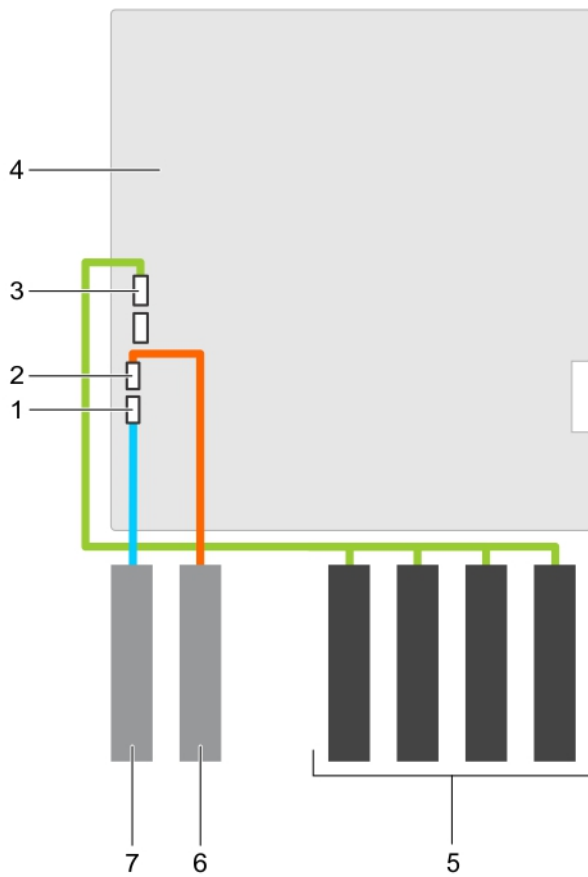

Figure 26. Cabling—Cabled hard-drives

- | | |
|---|--|
| 1. SATA optical drive connector on system board | 2. SATA tape drive connector on system board |
| 3. SATA A connector on system board | 4. system board |
| 5. hard drives | 6. tape drive |
| 7. optical drive | |

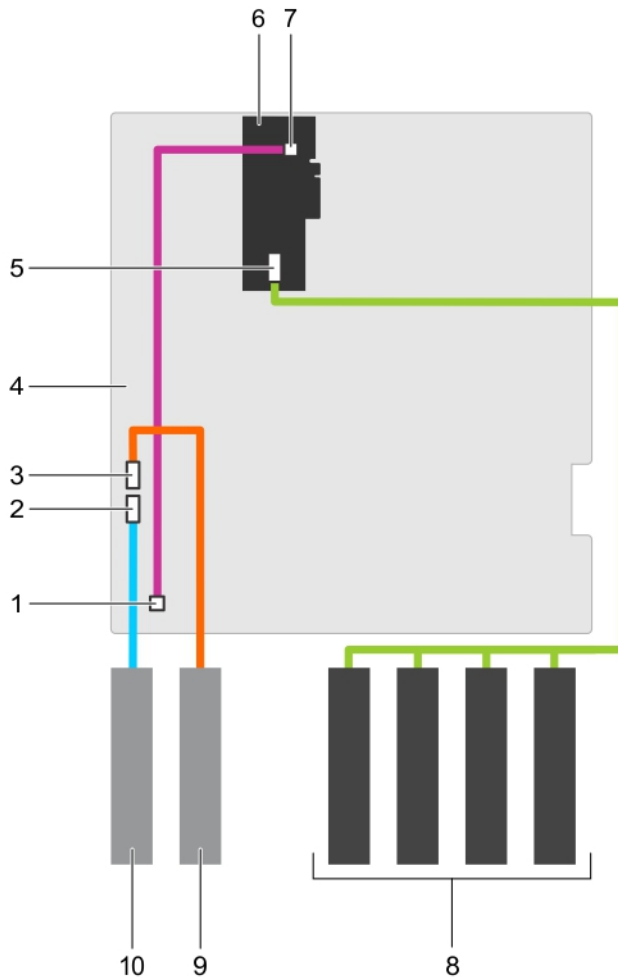

Figure 27. Cabling—Cabled hard-drives with a PERC card

- | | |
|---|---|
| 1. front-panel HDD LED controller connector on the system board | 2. SATA optical drive connector on system board |
| 3. SATA tape drive connector on system board | 4. system board |
| 5. SAS connector on PERC card | 6. PERC card |
| 7. front-panel HDD LED controller connector on the PERC card | 8. hard drives |
| 9. tape drive | 10. optical drive |

Next steps

1. Install the internal hard-drive bay into the chassis.
2. If disconnected, reconnect the power and data cable(s) to the remaining hard drive(s) in the internal hard-drive bay.

Related Links

- [Removing the internal hard-drive bay](#)
- [Installing a cabled hard drive](#)

Installing a cabled hard drive

Prerequisites

 **CAUTION:** Many repairs may only be done by a certified service technician. You should only perform troubleshooting and simple repairs as authorized in your product documentation, or as directed by the online or telephone service and support team. Damage due to servicing that is not authorized by Dell is not covered by your warranty. Read and follow the safety instructions that came with the product.

1. Ensure that you read the [Safety instructions](#).
2. Keep the #2 Phillips screwdriver ready.
3. Follow the procedure listed in [Before working inside your system](#).
4. Disconnect the power and data cables from the hard drive(s) in the internal hard-drive bay.
5. Remove the internal hard-drive bay.

Steps

1. Insert the hard drive into the internal hard-drive bay with the hard-drive connector facing outward.
2. Secure the hard drive to the internal hard-drive bay using the four screws.

 **NOTE:** When installing new hard drives into the internal hard-drive bay, use the spare hard-drive screws attached to the hard-drive bay.

Next steps

1. Follow the procedure listed in [After working inside your system](#).
2. Install the internal hard-drive bay into the chassis.
3. Connect the power and data cables to the hard drive(s).
4. Enter System Setup and ensure that the hard drive controller is enabled.
5. Exit System Setup and restart the system.
6. Install any software required for operating the hard drive as described in the documentation for the hard drive.

Related Links

[Removing the internal hard-drive bay](#)

[Installing the internal hard-drive bay](#)

[Removing a cabled hard drive](#)

Hard-drive backplane

Your system supports one of the following configurations:

- x8 SAS/SATA backplane for 3.5 inch hard drives
 -  **NOTE:** The x8 backplane also supports up to eight 2.5 inch (SAS, SATA, or SSD) hot-swappable hard drives installed in 3.5 inch hard-drive adapters, which are then installed in the 3.5 inch hard-drive carriers.
- x16 SAS/SATA backplane for 2.5 inch hard drives

 **NOTE:** Only systems with hot-swappable hard drives support hard-drive backplanes.

Removing the hard-drive backplane

Prerequisites

CAUTION: Many repairs may only be done by a certified service technician. You should only perform troubleshooting and simple repairs as authorized in your product documentation, or as directed by the online or telephone service and support team. Damage due to servicing that is not authorized by Dell is not covered by your warranty. Read and follow the safety instructions that came with the product.

1. Ensure that you read the [Safety instructions](#).
2. Follow the procedure listed in [Before working inside your system](#).

CAUTION: To prevent damage to the drives and backplane, remove the hard drives from the system before removing the backplane.

CAUTION: Note the slot number of each hard drive and temporarily label the slots before removing the hard drives so that you can replace them in the same locations.

3. Remove all hard drives.

Steps

1. Disconnect the SAS, power, and signal cables from the hard-drive backplane.

NOTE: For the x8 backplane, press the SAS connector and push the connector toward the top of the system to release the SAS cable from the backplane.

2. Pull the release pin and lift the backplane out of the system.

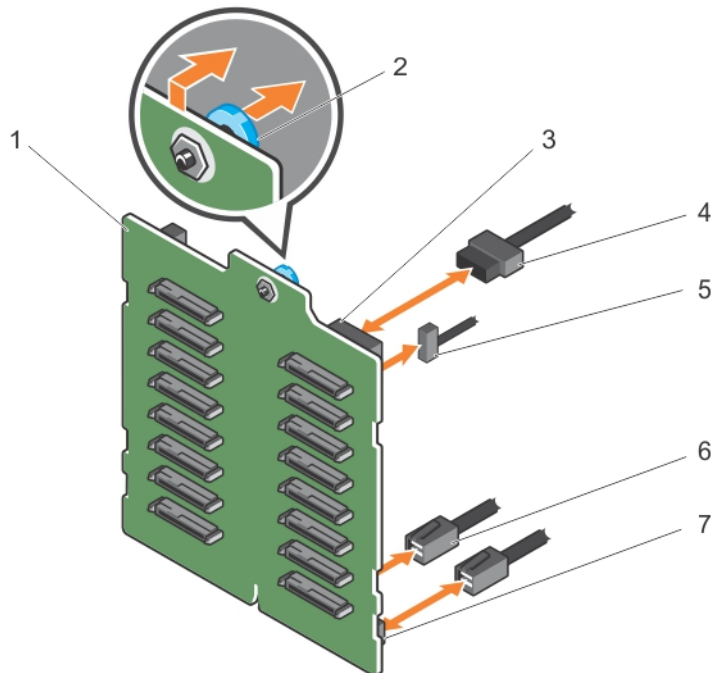

Figure 28. Removing and installing an x16 hard-drive backplane

- | | |
|-----------------------------|----------------|
| 1. x16 hard-drive backplane | 2. release pin |
| 3. power connector | 4. power cable |

- 5. signal cable
- 7. SAS connector

- 6. SAS cable

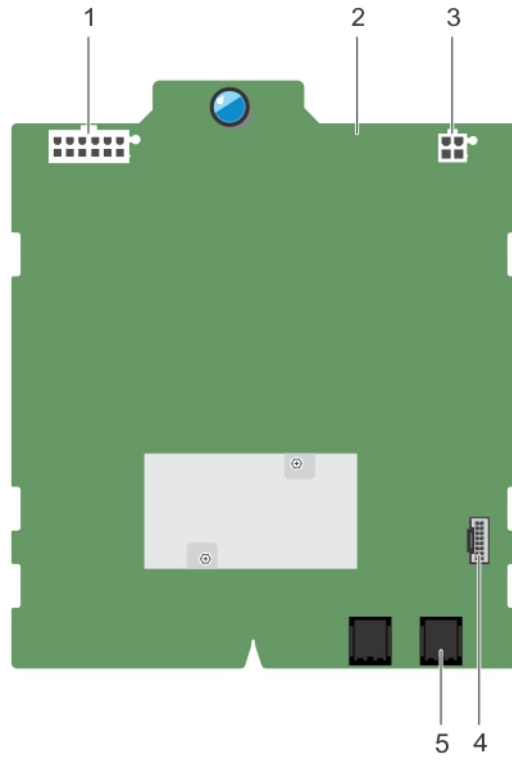

Figure 29. Connectors on an x16 hard-drive backplane

- 1. backplane power connector
- 2. x16 backplane
- 3. power connector for the optical and tape drives
- 4. signal connector
- 5. SAS A connector

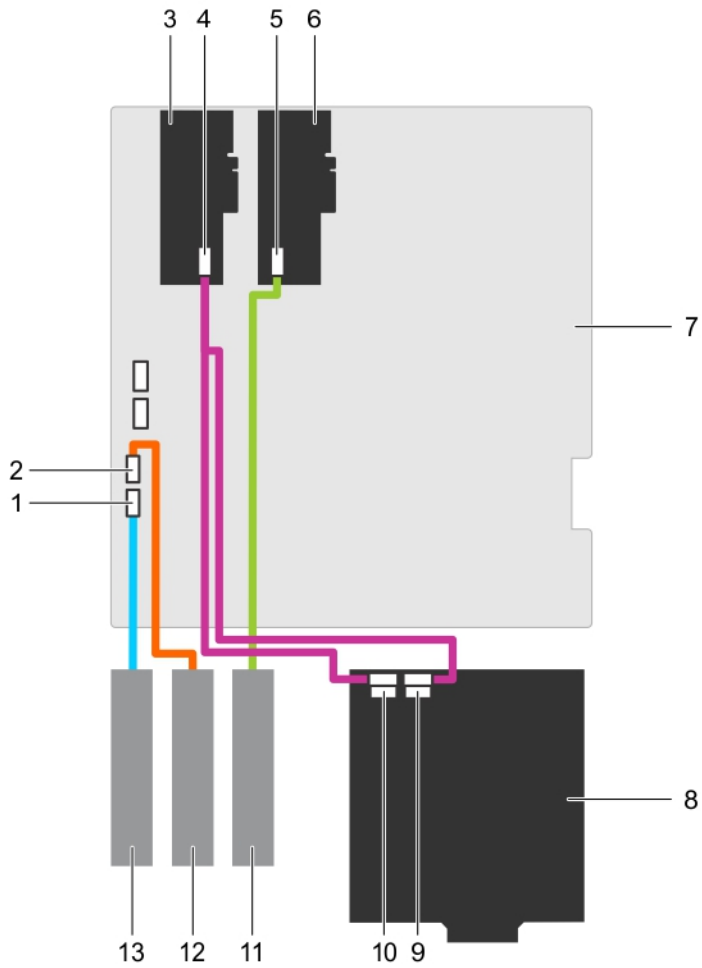

Figure 30. Cabling—x16 hard-drive backplane with two PERC cards

- | | |
|---|--|
| 1. SATA optical drive connector on system board | 2. SATA tape drive connector on system board |
| 3. PERC card | 4. SAS connector on PERC card |
| 5. SAS connector on PERC card | 6. PERC card |
| 7. system board | 8. x16 backplane |
| 9. SAS B connector on the x16 backplane | 10. SAS A connector on the x16 backplane |
| 11. SAS tape drive | 12. SATA tape drive |
| 13. optical drive | |

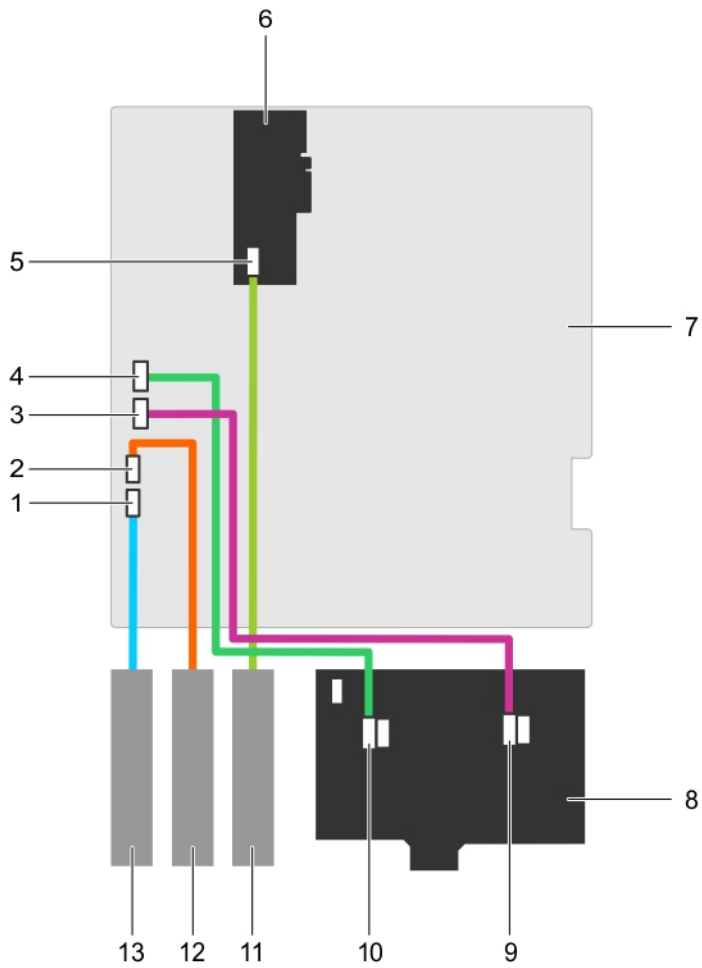

Figure 31. Cabling—x8 hard-drive backplane with one PERC card

- | | |
|---|--|
| 1. SATA optical drive connector on system board | 2. SATA tape drive connector on system board |
| 3. SATA B connector on system board | 4. SATA A connector on system board |
| 5. SAS connector on PERC card | 6. PERC card |
| 7. system board | 8. x8 backplane |
| 9. SAS B connector on backplane | 10. SAS A connector on backplane |
| 11. SAS tape drive | 12. SATA tape drive |
| 13. optical drive | |

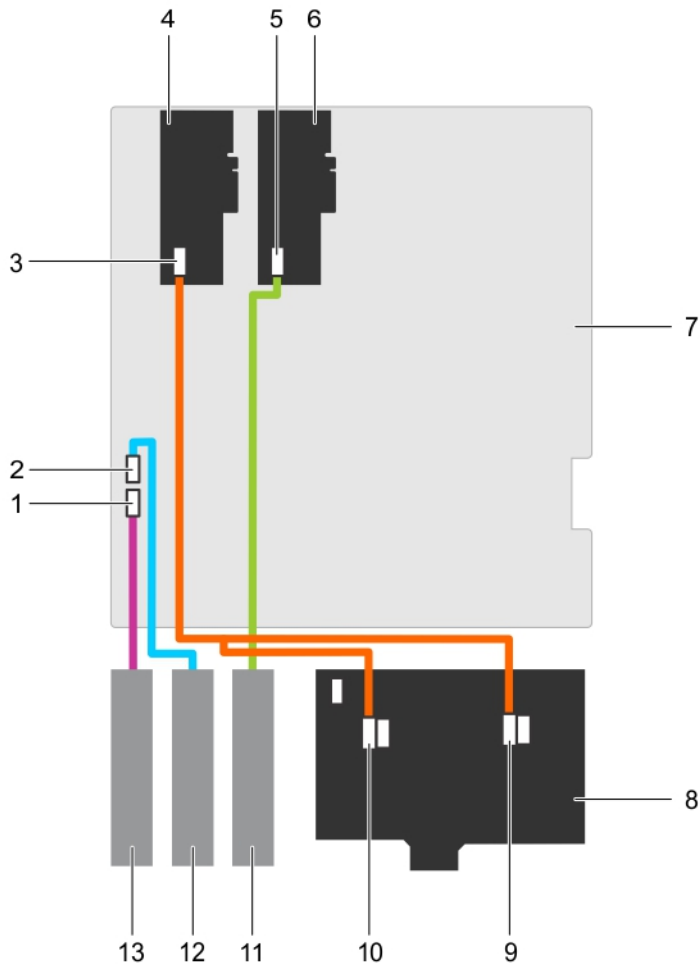

Figure 32. Cabling—x8 hard-drive backplane with two PERC cards

- | | |
|---|--|
| 1. SATA optical drive connector on system board | 2. SATA tape drive connector on system board |
| 3. SAS connector on PERC card | 4. PERC card |
| 5. SAS connector on PERC card | 6. PERC card |
| 7. system board | 8. x8 backplane |
| 9. SAS B connector on backplane | 10. SAS A connector on backplane |
| 11. SAS tape drive | 12. SATA tape drive |
| 13. optical drive | |

Related Links

- [Removing the front bezel](#)
- [Installing the hard-drive backplane](#)

Installing the hard-drive backplane

Prerequisites

-  **CAUTION:** Many repairs may only be done by a certified service technician. You should only perform troubleshooting and simple repairs as authorized in your product documentation, or as directed by the online or telephone service and support team. Damage due to servicing that is not authorized by Dell is not covered by your warranty. Read and follow the safety instructions that came with the product.

Ensure that you read the [Safety instructions](#).

Steps

1. Use the hooks at the back of the hard-drive bay as guides to align the hard-drive backplane.
2. Slide down the hard-drive backplane until the release pin locks into the slot.
3. Connect the SAS, power, signal, and I2C cables to the hard-drive backplane.

Next steps

1. Install the hard drives in their original locations.
2. Follow the procedure listed in [After working inside your system](#).

Related Links

[Removing the hard-drive backplane](#)

Four-slot hard-drive blank

Systems with x8 hard-drive backplanes configured for software RAID support only four hard drives. The remaining hard-drive slots are pre-installed with the four-slot hard-drive blank, and are not available for software RAID.

Removing a four-slot hard-drive blank

Prerequisites

-  **CAUTION:** To maintain proper system cooling, all empty hard-drive slots must have hard-drive blanks installed.

-  **NOTE:** This is a service only procedure.

1. Ensure that you read the [Safety instructions](#).
2. Follow the procedure listed in [Before working inside your system](#).

-  **CAUTION:** To prevent damage to the hard drives and backplane, you must remove the hard drives from the system before removing the backplane.

-  **CAUTION:** Note the slot number of each hard drive and temporarily label the slots before removing the hard drives so that you can replace them in the same location(s).

3. Remove all hard drives.
4. Remove the cooling shroud.
5. Remove the x8 hard-drive backplane.

Steps

1. Using a screwdriver, push the release tabs on the four corners of the blank from inside the system, to unlock the four-slot hard-drive blank from the chassis.
2. From the front of the system, pull the four-slot hard-drive blank at the corners until it is free of the hard-drive slot.

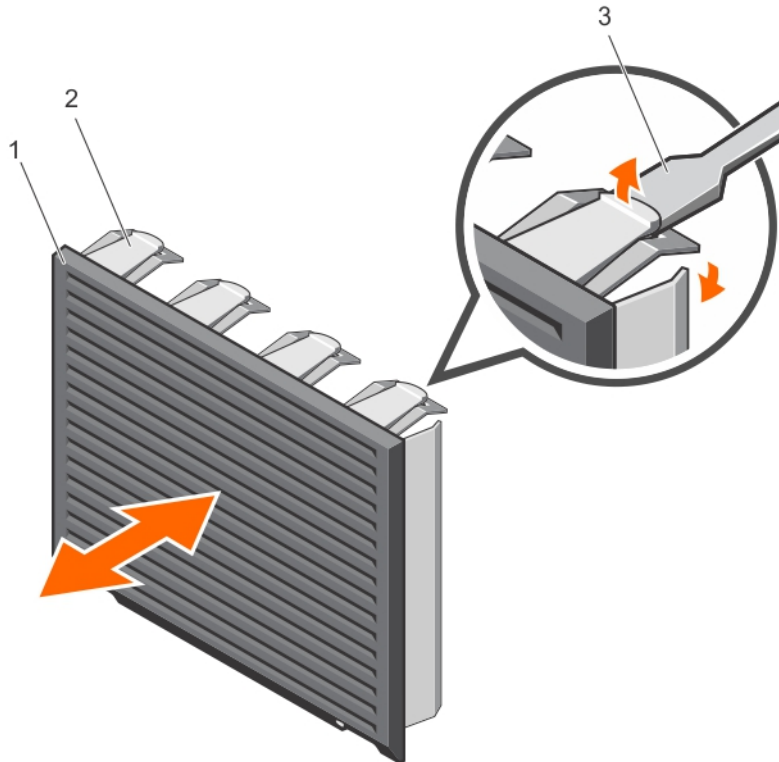

Figure 33. Installing and removing the four-slot hard-drive blank

- | | |
|-------------------------------|----------------|
| 1. four-slot hard-drive blank | 2. release tab |
| 3. screwdriver | |

Related Links

- [Removing the cooling shroud](#)
- [Removing the hard-drive backplane](#)
- [Installing a four-slot hard-drive blank](#)

Installing a four-slot hard-drive blank

Prerequisites

Ensure that you read the [Safety instructions](#).

Steps

1. Locate the hard drive slots numbered from four to seven.
2. Insert the four-slot hard-drive blank into the hard-drive slot, and push it until the release tabs click into place.

Next steps

Follow the instructions listed in [After working inside your system](#).

Related Links

[Removing a four-slot hard-drive blank](#)

System memory

Your system supports DDR4 registered DIMMs (RDIMMs). It supports DDR4 voltage specifications.

 **NOTE:** MT/s indicates DIMM speed in MegaTransfers per second.

Memory bus operating frequency can be 2133 MT/s, 1866 MT/s, 1600 MT/s, or 1333 MT/s depending on:

- System profile selected (for example, Performance Optimized, Custom, or Dense Configuration Optimized)
- Maximum supported DIMM frequency of the processors

Your system contains 12 memory sockets split into four sets— two sets of 4 sockets and two sets of 2 sockets each. DIMMs in sockets A1 to A8 are assigned to processor 1 and DIMMs in sockets B1 to B4 are assigned to processor 2. Each 4-socket set is organized into two channels and each 2-socket set is organized into one channel. In each channel of the 4-socket set, the release levers of the first socket are marked white and those of the second socket are marked black. In the 2-socket set, each release lever is marked white.

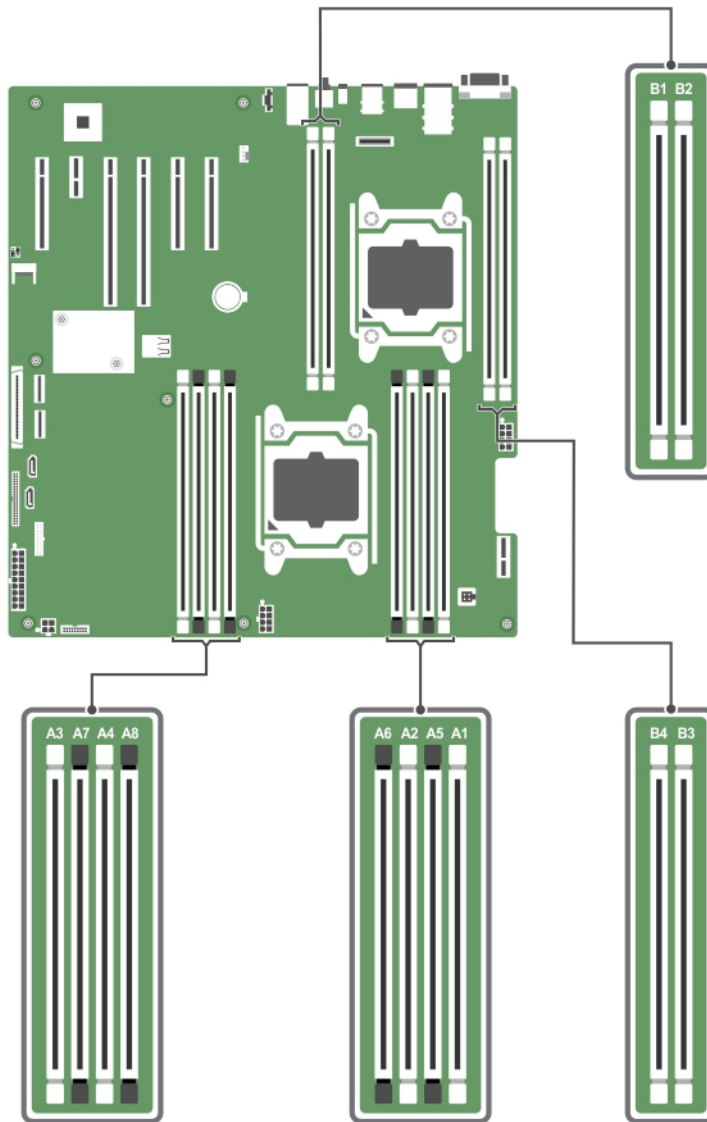

Figure 34. Memory socket locations

Memory channels are organized as follows:

- | | |
|--------------------|----------------------------|
| Processor 1 | channel 0: slots A1 and A5 |
| | channel 1: slots A2 and A6 |
| | channel 2: slots A3 and A7 |
| | channel 3: slots A4 and A8 |
| Processor 2 | channel 0: slot B1 |
| | channel 1: slot B2 |
| | channel 2: slot B3 |

channel 3: slot B4

The following table shows the memory populations and operating frequencies for the supported configurations.

DIMM Type	DIMMs Populated/ Channel	Operating Frequency (in MT/s)	Maximum DIMM Rank/Channel
1.2 V			
RDIMM	1 2	2133, 1866, 1600, and 1333	Single rank or dual rank

General memory module installation guidelines

Your system supports Flexible Memory Configuration, enabling the system to be configured and run in any valid chipset architectural configuration. The following are the recommended guidelines for installing memory modules:

- x4 and x8 DRAM based DIMMs can be mixed. For more information, see [Mode-specific guidelines](#).
- Up to two dual- or single-rank RDIMMs can be populated per channel.
- Populate DIMM sockets only if a processor is installed. For single-processor systems, sockets A1 to A8 are available. For dual-processor systems, sockets A1 to A8 and sockets B1 to B4 are available.
- Populate all sockets with white release levers first, and then all the sockets with black release levers.
- When mixing memory modules with different capacities, populate the sockets with memory modules with highest capacity first. For example, if you want to mix 4 GB and 8 GB DIMMs, populate 8 GB DIMMs in the sockets with white release levers and 4 GB DIMMs in the sockets with black release levers.
- In a dual-processor configuration, the memory configuration for each processor should be identical through the first eight slots. For example, if you populate socket A1 for processor 1, then populate socket B1 for processor 2, and so on.
- Memory modules of different capacities can be mixed provided other memory population rules are followed (for example, 4 GB and 8 GB memory modules can be mixed).
- Mixing of more than two DIMM capacities in a system is not supported.
- Populate two DIMMs per processor (one DIMM per channel) at a time to maximize performance.

Mode-specific guidelines

Four memory channels are allocated to each processor. The allowable configurations depend on the memory mode selected.

 **NOTE:** You can mix x4 and x8 DRAM based DIMMs to support RAS features. However, all guidelines for specific RAS features must be followed. x4 DRAM based DIMMs retain Single Device Data Correction (SDDC) in memory optimized (independent channel) mode. x8 DRAM based DIMMs require Advanced ECC mode to gain SDDC.

The following sections provide additional slot population guidelines for each mode:

Advanced ECC (lockstep)

Advanced ECC mode extends SDDC from x4 DRAM based DIMMs to both x4 and x8 DRAMs. This protects against single DRAM chip failures during normal operation.

Memory installation guidelines:

- Memory modules must be identical in size, speed, and technology.
- DIMMs installed in memory sockets with white release levers must be identical and similar rule applies for sockets with black release levers. This ensures that identical DIMMs are installed in matched pairs - for example, A1 with A2, A3 with A4, A5 with A6, and so on.

 **NOTE:** Advanced ECC with Mirroring is not supported.

Memory optimized (independent channel) mode

This mode supports SDDC only for memory modules that use x4 device width, and the mode does not impose any specific slot population requirements.

Memory sparing

 **NOTE:** To use memory sparing, this feature must be enabled in the System Setup.

In this mode, one rank per channel is reserved as a spare. If persistent correctable errors are detected on a rank, the data from this rank is copied to the spare rank and the failed rank is disabled.

With memory sparing enabled, the system memory available to the operating system is reduced by one rank per channel. For example, in a dual-processor configuration with sixteen 4 GB dual-rank DIMMs, the available system memory is: $\frac{3}{4}$ (ranks/channel) \times 16 (DIMMs) \times 4 GB = 48 GB, and not 16 (DIMMs) \times 4 GB = 64 GB.

 **NOTE:** Memory sparing does not offer protection against a multi-bit uncorrectable error.

 **NOTE:** Both Advanced ECC/Lockstep and Optimizer modes support Memory Sparing.

Sample memory configurations

The following tables show sample memory configurations for one and two processor configurations that follow the appropriate memory guidelines.

 **NOTE:** 1R and 2R in the following tables indicate single- and dual-rank DIMMs respectively.

Table 1. Memory configurations—single processor

System Capacity (in GB)	DIMM Size (in GB)	Number of DIMMs	DIMM Rank, Organization, and Frequency	DIMM Slot Population
4	4	1	1R, x8, 2133 MT/s,	A1
			1R, x8, 1866 MT/s	
8	4	2	1R, x8, 2133 MT/s,	A1, A2
			1R, x8, 1866 MT/s	
16	4	4	1R, x8, 2133 MT/s,	A1, A2, A3, A4
			1R, x8, 1866 MT/s	
	8	2	2R, x8, 2133 MT/s,	A1, A2
			2R, x8, 1866 MT/s	

System Capacity (in GB)	DIMM Size (in GB)	Number of DIMMs	DIMM Rank, Organization, and Frequency	DIMM Slot Population
24	4	6	1R, x8, 2133 MT/s, 1R, x8, 1866 MT/s	A1, A2, A3, A4, A5, A6
48	8	6	2R, x8, 2133 MT/s, 2R, x8, 1866 MT/s	A1, A2, A3, A4, A5, A6
96	16	6	2R, x4, 2133 MT/s, 2R, x4, 1866 MT/s	A1, A2, A3, A4, A5, A6
128	16	8	2R, x4, 2133 MT/s, 2R, x4, 1866 MT/s,	A1, A2, A3, A4, A5, A6, A7, A8
192	32	6	RDIMM, 2R, x4, 2133 MT/s RDIMM, 2R, x4, 1866 MT/s	A1, A2, A3, A4, A5, A6

Table 2. Memory configurations—two processors

System Capacity (in GB)	DIMM Size (in GB)	Number of DIMMs	DIMM Rank, Organization, and Frequency	DIMM Slot Population
16	4	4	1R, x8, 2133 MT/s, 1R, x8, 1866 MT/s	A1, A2, B1, B2
32	4	8	1R, x8, 2133 MT/s, 1R, x8, 1866 MT/s	A1, A2, A3, A4, B1, B2, B3, B4
64	8	8	2R, x8, 2133 MT/s, 2R, x8, 1866 MT/s	A1, A2, A3, A4, B1, B2, B3, B4
96	8	12	2R, x8, 2133 MT/s, 2R, x8, 1866 MT/s	A1, A2, A3, A4, A5, A6, A7, A8, B1, B2, B3, B4
128	16	8	2R, x4, 2133 MT/s, 2R, x4, 1866 MT/s	A1, A2, A3, A4, B1, B2, B3, B4
160	16 and 8	12	2R, x4, 2133 MT/s, 2R, x8, 2133 MT/s, 2R, x4, 1866 MT/s	A1, A2, A3, A4, A5, A6, A7, A8, B1, B2, B3, B4

System Capacity (in GB)	DIMM Size (in GB)	Number of DIMMs	DIMM Rank, Organization, and Frequency	DIMM Slot Population
			2R, x8, 1866 MT/s	 NOTE: 16 GB DIMMs must be installed in slots numbered A1, A2, A3, A4, B1, B2, B3, and B4 and 8 GB DIMMs must be installed in slots A5, A6, A7, and A8.
192	16	12	2R, x4, 2133 MT/s, 2R, x4, 1866 MT/s	A1, A2, A3, A4, A5, A6,A7,A8, B1, B2, B3, B4
384	32	12	RDIMM, 2R, x4, 2133 MT/s RDIMM, 2R, x4, 1866 MT/s	A1, A2, A3, A4, A5, A6,A7,A8, B1, B2, B3, B4

Removing memory modules

Prerequisites

 **CAUTION:** Many repairs may only be done by a certified service technician. You should only perform troubleshooting and simple repairs as authorized in your product documentation, or as directed by the online or telephone service and support team. Damage due to servicing that is not authorized by Dell is not covered by your warranty. Read and follow the safety instructions that came with the product.

1. Ensure that you read the [Safety instructions](#).
2. Follow the procedure listed in [Before working inside your system](#).
3. Remove the cooling shroud.

 **WARNING:** The memory modules are hot to the touch for some time after the system has been powered down. Allow time for the memory modules to cool before handling them. Handle the memory modules by the card edges and avoid touching the components or metallic contacts on the memory module.

Steps

1. Locate the appropriate memory module socket.

 **CAUTION:** Handle each memory module only by the card edges, making sure not to touch the middle of the memory module or metallic contacts.

2. To release the memory module from the socket, simultaneously press the ejectors on both ends of the memory-module socket.

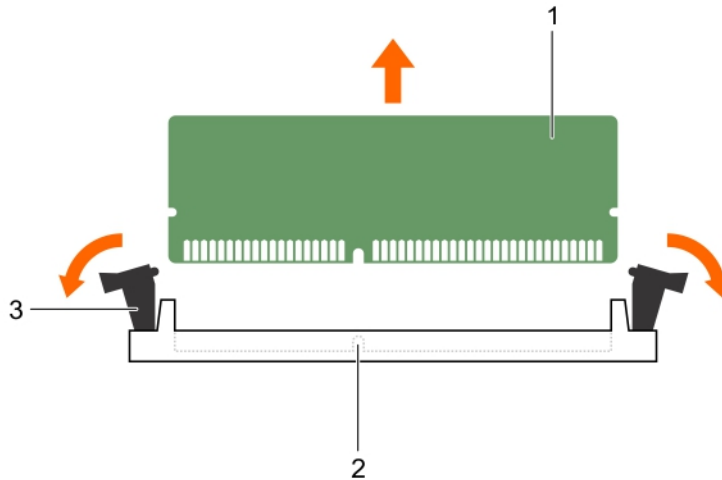

Figure 35. Removing and installing a memory module

1. memory module
2. memory-module socket
3. memory-module socket ejector (2)

Related Links

[Removing the cooling shroud](#)

[Installing memory modules](#)

Installing memory modules

Prerequisites

CAUTION: Many repairs may only be done by a certified service technician. You should only perform troubleshooting and simple repairs as authorized in your product documentation, or as directed by the online or telephone service and support team. Damage due to servicing that is not authorized by Dell is not covered by your warranty. Read and follow the safety instructions that came with the product.

1. Ensure that you read the [Safety instructions](#).
2. Follow the procedure listed in [Before working inside your system](#).
3. Remove the cooling shroud.

WARNING: The memory modules are hot to the touch for some time after the system has been powered down. Allow time for the memory modules to cool before handling them. Handle the memory modules by the card edges and avoid touching the components or metallic contacts on the memory module.

Steps

1. Locate the appropriate memory-module socket.

CAUTION: Handle each memory module only by the card edges, making sure not to touch the middle of the memory module or metallic contacts.

CAUTION: To prevent damage to the memory module or the memory-module socket during installation, do not bend or flex the memory module; insert both ends of the memory module simultaneously.

2. Align the edge connector of the memory module with the alignment key of the memory module socket, and insert the memory module in the socket.

NOTE: The alignment key allows you to install the memory module in the socket in only one way.

CAUTION: Do not apply pressure at the center of the memory module; apply pressure at both ends of the memory module evenly.

3. Press the memory module with your thumbs until the socket levers firmly click into place.

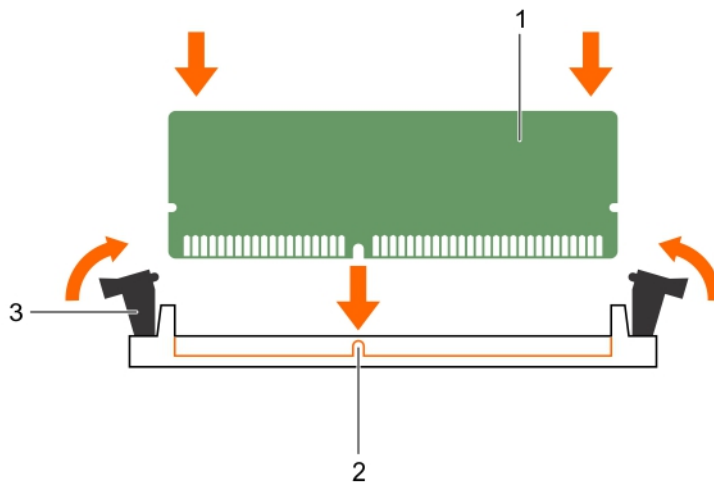

Figure 36. Installing the memory module

1. memory module
2. alignment key
3. memory-module socket ejector (2)

Next steps

1. Install the cooling shroud.
2. Follow the procedure listed in [After working inside your system](#).
3. Press <F2> to enter System Setup, and check the **System Memory** setting. The system should have already changed the value to reflect the installed memory.
4. If the value is incorrect, one or more of the memory modules may not be installed properly. Ensure that the memory modules are firmly seated in the sockets.
5. Run system memory test in system diagnostics. See [Dell Embedded System Diagnostics](#).

Related Links

- [Removing the cooling shroud](#)
- [Installing the cooling shroud](#)
- [Removing memory modules](#)

Cooling fans

The system supports the following:

- An internal cooling fan
- An optional external cooling fan at the back of the chassis

 **NOTE:** When selecting or upgrading your system configuration, verify the system power consumption with the Dell Energy Smart Solution Advisor at dell.com/ESSA to ensure optimum power utilization.

Removing the internal cooling fan

Prerequisites

 **CAUTION:** Many repairs may only be done by a certified service technician. You should only perform troubleshooting and simple repairs as authorized in your product documentation, or as directed by the online or telephone service and support team. Damage due to servicing that is not authorized by Dell is not covered by your warranty. Read and follow the safety instructions that came with the product.

 **CAUTION:** Never operate your system with the internal cooling fan removed. The system can overheat and result in shutdown of the system and loss of data.

 **CAUTION:** Do not operate the system with the cover removed for a duration exceeding 5 minutes.

1. Ensure that you read the [Safety instructions](#).
2. Follow the procedure listed in [Before working inside your system](#).
3. Remove the cooling shroud.

Steps

1. Disconnect the internal cooling fan power cable from the system board.
2. Press the release tab on the internal cooling fan, and holding the internal cooling fan by the sides, slide it out in the direction of the arrow marked on the fan.

 **CAUTION:** Do not remove or install the internal cooling fan by holding the fan blades.

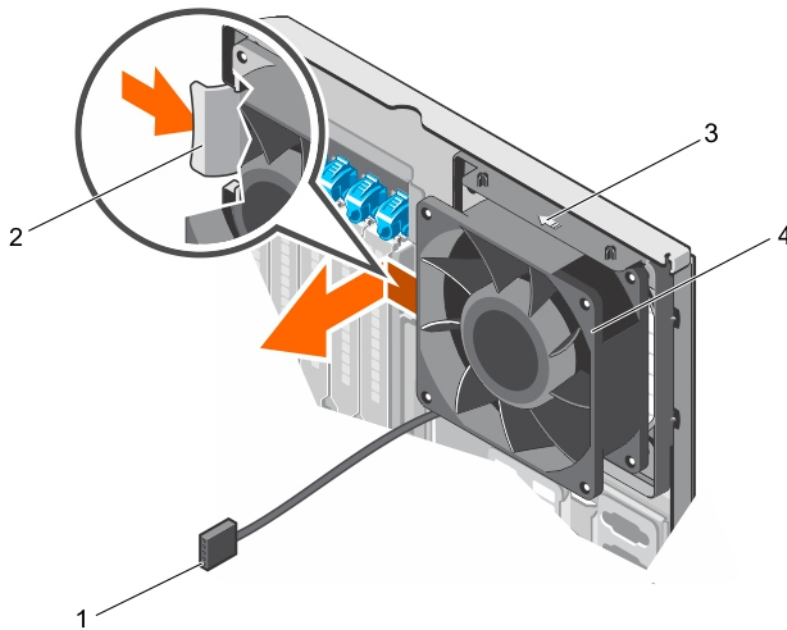

Figure 37. Removing and installing the internal cooling fan

- | | |
|-------------------------------------|-------------------------|
| 1. internal cooling fan power cable | 2. release tab |
| 3. arrow | 4. internal cooling fan |

Related Links

- [Removing the cooling shroud](#)
- [Installing the internal cooling fan](#)

Installing the internal cooling fan

Prerequisites

△ CAUTION: Many repairs may only be done by a certified service technician. You should only perform troubleshooting and simple repairs as authorized in your product documentation, or as directed by the online or telephone service and support team. Damage due to servicing that is not authorized by Dell is not covered by your warranty. Read and follow the safety instructions that came with the product.

△ CAUTION: Do not operate the system with the cover removed for a duration exceeding 5 minutes.

Ensure that you read the [Safety instructions](#).

Steps

1. Hold the cooling fan by the sides with the cable end facing the bottom of the chassis.

△ CAUTION: Do not remove or install the internal cooling fan by holding the fan blades.

2. Align the four tabs on the internal cooling fan with the four slots on the chassis wall.
3. Press and slide the internal cooling fan into the slots until the release tab locks into place.

 **CAUTION: Do not remove or install the internal cooling fan by holding the blades.**

4. Connect the internal cooling fan power cable to the FAN1 connector on the system board.

Next steps

1. Install the cooling shroud.
2. Follow the procedure listed in [After working inside your system](#).

Related Links

[Installing the cooling shroud](#)

[Removing the internal cooling fan](#)

Removing the external cooling fan

Prerequisites

 **CAUTION: Many repairs may only be done by a certified service technician. You should only perform troubleshooting and simple repairs as authorized in your product documentation, or as directed by the online or telephone service and support team. Damage due to servicing that is not authorized by Dell is not covered by your warranty. Read and follow the safety instructions that came with the product.**

1. Ensure that you read the [Safety instructions](#).
2. Follow the procedure listed in [Before working inside your system](#).
3. Remove the cooling shroud.

Steps

1. Disconnect the external cooling fan power cable from the system board.
2. Remove the four screws that secure the external cooling fan to the chassis.
3. Lift the external cooling fan to disengage the upper and the lower hooks from the slots on the chassis wall and remove the cooling fan.
4. Remove the external cooling fan power cable from of the system through the external cooling fan power cable slot at the back of the chassis.

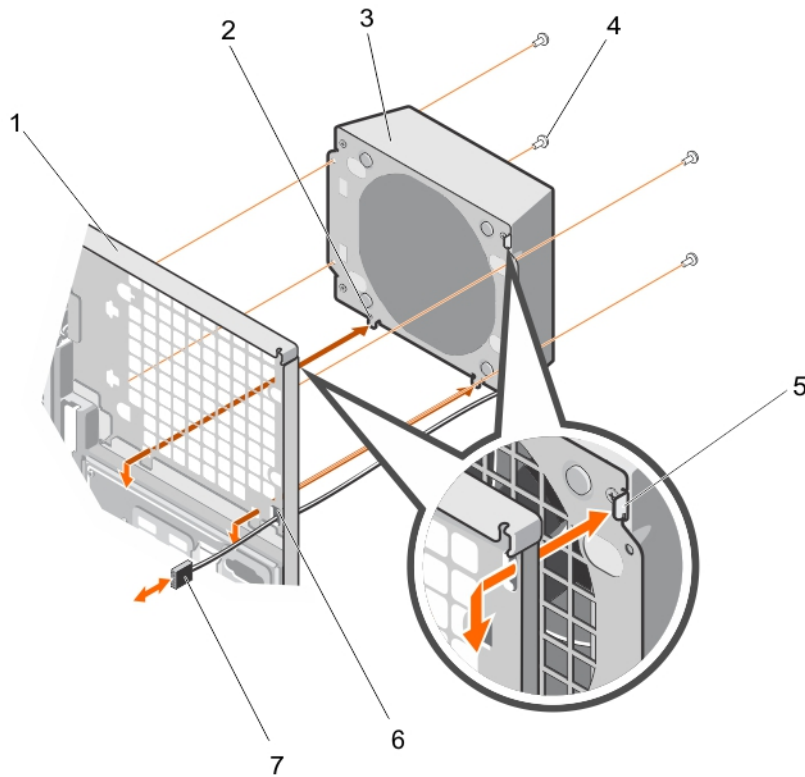

Figure 38. Removing and Installing the external cooling fan

- | | |
|-------------------------------------|--|
| 1. back of the system chassis | 2. bottom hook (2) |
| 3. external cooling fan | 4. screw (4) |
| 5. upper hook | 6. external cooling fan power cable slot |
| 7. external cooling fan power cable | |

Related Links

- [Removing the cooling shroud](#)
- [Installing the external cooling fan](#)

Installing the external cooling fan

Prerequisites

⚠ CAUTION: Many repairs may only be done by a certified service technician. You should only perform troubleshooting and simple repairs as authorized in your product documentation, or as directed by the online or telephone service and support team. Damage due to servicing that is not authorized by Dell is not covered by your warranty. Read and follow the safety instructions that came with the product.

Ensure that you follow the [Safety instructions](#).

Steps

1. Route the external cooling fan power cable into the system through the external cooling fan power cable slot at the back of the chassis.
2. Align and insert the lower and upper hooks on the external cooling fan into the corresponding slots at the back of the chassis.
3. Use the four screws to secure the external cooling fan to the chassis.
4. Connect the external cooling fan power cable to the FAN2 connector on the system board.

Next steps

1. Install the cooling shroud.
2. Follow the procedure listed in [After working inside your system](#).

Related Links

[Installing the cooling shroud](#)

[Removing the external cooling fan](#)

Internal USB memory key (optional)

An optional USB memory key installed inside your system can be used as a boot device, security key, or mass storage device. The USB connector must be enabled by the **Internal USB Port** option in the **Integrated Devices** screen of System Setup.

To boot from the USB memory key, configure the USB memory key with a boot image and then specify the USB memory key in the boot sequence in System Setup.

 **NOTE:** To locate the internal USB connector (INT_USB) on the system board, see [System board connectors](#).

Replacing the internal USB key

Prerequisites

 **CAUTION:** Many repairs may only be done by a certified service technician. You should only perform troubleshooting and simple repairs as authorized in your product documentation, or as directed by the online or telephone service and support team. Damage due to servicing that is not authorized by Dell is not covered by your warranty. Read and follow the safety instructions that came with the product.

1. Ensure that you read the [Safety instructions](#).
2. Follow the procedure listed in [Before working inside your system](#).

Steps

1. Locate the USB connector/USB key on the system board.

 **NOTE:** To locate the internal USB connector on the system board, see [System board connectors](#).

2. If installed, remove the USB key.
3. Insert the new USB key into the USB connector.

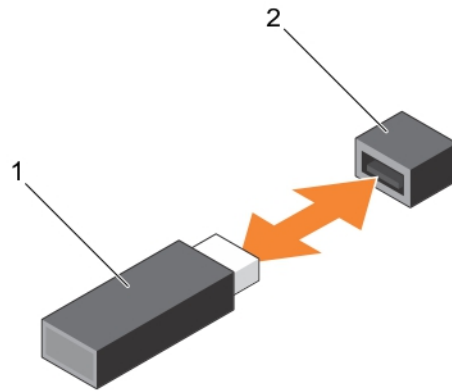

Figure 39. Replacing the internal USB key

1. USB memory key
2. USB memory key connector

Next steps

1. Follow the procedure listed in [After working inside your system](#).
2. While booting, press <F2> to enter System Setup and verify that USB key is detected by the system.

Expansion card holder

Removing the expansion card holder

Prerequisites

⚠ CAUTION: Many repairs may only be done by a certified service technician. You should only perform troubleshooting and simple repairs as authorized in your product documentation, or as directed by the online or telephone service and support team. Damage due to servicing that is not authorized by Dell is not covered by your warranty. Read and follow the safety instructions that came with the product.

1. Ensure that you read the [Safety instructions](#).
2. Follow the procedure listed in [Before working inside your system](#).

Steps

Press the tab and remove the expansion-card holder from the chassis.

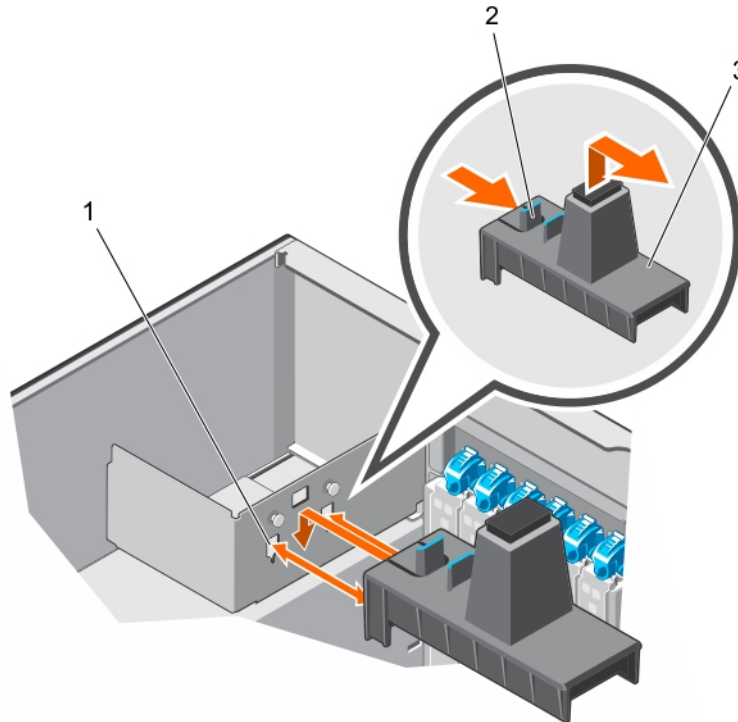

Figure 40. Removing and installing the expansion card holder

1. projection (2)
2. tab
3. expansion card holder

Installing the expansion card holder

Prerequisites

⚠ CAUTION: Many repairs may only be done by a certified service technician. You should only perform troubleshooting and simple repairs as authorized in your product documentation, or as directed by the online or telephone service and support team. Damage due to servicing that is not authorized by Dell is not covered by your warranty. Read and follow the safety instructions that came with the product.

Ensure that you read the [Safety instructions](#).

Steps

Align the expansion card holder with the projections on the chassis and push it down until firmly seated.

Next steps

Follow the procedure listed in [After working inside your system](#).

Expansion cards

Expansion card installation guidelines

Table 3. PCI Express Generation 3 expansion cards supported

PCIe Slot	Processor Connection	Height	Length	Link Width	Slot Width
1	Platform Controller Hub	Full Height	Half Length	x4	x8
2	Platform Controller Hub	Full Height	Half Length	x1	x1
3	Processor 1	Full Height	Full Length	x16	x16
4	Processor 1	Full Height	Full Length	x16	x16
5	Processor 2	Full Height	Half Length	x8	x8
6	Processor 2	Full Height	Half Length	x8	x8

 **NOTE:** Only slots 3, 4, 5, and 6 support Generation 3 PCIe expansion cards.

 **NOTE:** Do not use slots 5 and 6 for single processor configuration (CPU1).

 **NOTE:** When your system is installed with a double-width GPU card in slot 3, you cannot install an expansion card in slot 2.

 **NOTE:** When your system is installed with a double-width GPU card in slot 4, you cannot install an expansion card in slot 3.

 **NOTE:** The expansion cards are not hot-swappable.

The following table provides a guide for installing expansion cards to ensure proper cooling and mechanical fit. The expansion cards with the highest priority must be installed first using the slot priority indicated. All other expansion cards must be installed following the card priority and slot priority order.

Table 4. Expansion card installation order

Card Priority	Card Type	Slot Priority	Maximum Allowed
1	GPU	4	1
	GPU (AMD W7000)	3, 4	2
2	RAID	3, 4	2
	RAID (H830)	3, 4, 5, 6	4
3	10 Gb NICs	3, 4, 5, 6, 1	5
4	FC8 HBA	3, 4, 5, 6, 1	5
5	1 Gb NICs	3, 4, 5, 6, 1	5
	1 Gb NIC (Broadcom Dual Port)	3, 4, 5, 6, 1, 2	6
6	Non-RAID	3, 4, 5, 6	4

GPU card installation guidelines

Observe the following guidelines while installing a GPU card:

- Ensure that all GPU cards are of the same type or model.
- Your system supports only Q4000 single-width GPU cards and Q6000 double-width GPU card.
- You can install one double-width or two single-width cards on slots 3 and 5 on a dual-processor system.
- Systems with a double-width GPU card can support only one 5.25 inch removable media storage device.
- GPU cards must be installed on a system with redundant 1100 W AC power supplies.
- Your system supports GPU cards of only 300 W or less.

Removing an expansion card

Prerequisites



CAUTION: Many repairs may only be done by a certified service technician. You should only perform troubleshooting and simple repairs as authorized in your product documentation, or as directed by the online or telephone service and support team. Damage due to servicing that is not authorized by Dell is not covered by your warranty. Read and follow the safety instructions that came with the product.

1. Ensure that you read the [Safety instructions](#).
2. Follow the procedure listed in [Before working inside your system](#).
3. Remove the expansion-card holder.

Steps

1. Disconnect the data cables from the PERC card and/or the power cables from the GPU card.
2. Open the expansion-card latch in the direction of the arrow shown in the following figure.
3. Hold the expansion card by its edge, pull the card up to remove it from the expansion-card slot and out of the system.
4. Install the filler bracket by performing the following steps:
 - a. Align the tab on the filler bracket with the expansion card slot.
 - b. Press the expansion-card latch until the filler bracket locks into place.



NOTE: Filler brackets must be installed over empty expansion-card slots to maintain FCC certification of the system. The brackets also keep dust and dirt out of the system and aid in proper cooling and airflow inside the system.

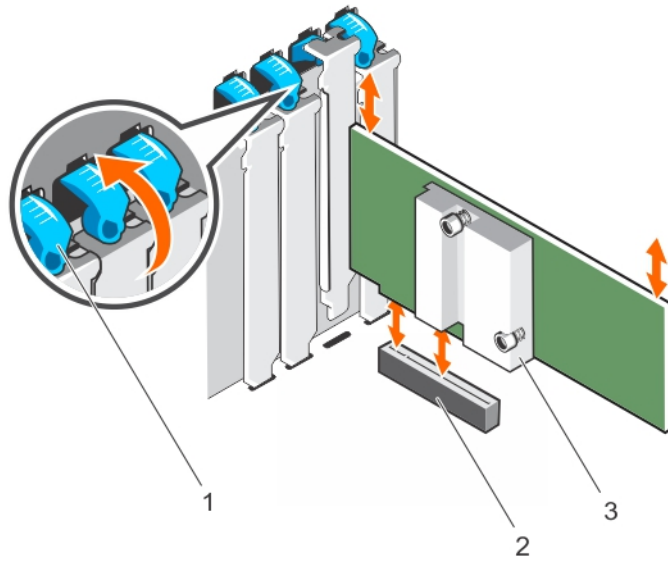

- | | |
|-------------------------|-----------------------------|
| 1. expansion card latch | 2. expansion card connector |
| 3. expansion card | |

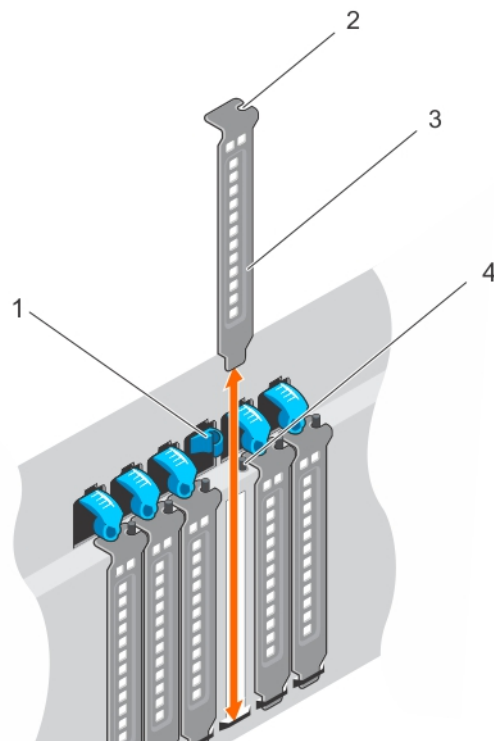

Figure 41. Removing and installing the filler bracket

- | | |
|-------------------------|--------------|
| 1. expansion card latch | 2. slot |
| 3. filler bracket | 4. guide pin |

Related Links

- [Removing the expansion card holder](#)
- [Installing an expansion card](#)

Installing an expansion card

Prerequisites

 **CAUTION:** Many repairs may only be done by a certified service technician. You should only perform troubleshooting and simple repairs as authorized in your product documentation, or as directed by the online or telephone service and support team. Damage due to servicing that is not authorized by Dell is not covered by your warranty. Read and follow the safety instructions that came with the product.

1. Ensure that you read the [Safety instructions](#).
2. Follow the procedure listed in [Before working inside your system](#).
3. Removing the cooling shroud.
4. Remove the expansion-card holder.

Steps

1. Unpack the expansion card and prepare it for installation.
For instructions, see the documentation accompanying the card.
2. Open the expansion-card latch for the slot you want to install the expansion card.
3. Remove the filler bracket by performing the following steps.
 - a. Open the two expansion card latches.
 - b. Slide the filler brackets out from the system.

 **NOTE:** Keep this bracket in case you need to remove the expansion card. Filler brackets must be installed in empty expansion-card slots to maintain FCC certification of the system. The brackets also keep dust and dirt out of the system and aid in proper cooling and airflow inside the system.
4. Holding the card by its edges, position the card so that the card-edge connector aligns with the expansion card connector.
5. Insert the card-edge connector firmly into the expansion card connector until the card is fully seated.
6. Close the expansion-card latch by pushing the latch up until the latch snaps into place.
7. Connect any cables to the expansion card.
8. Replace the expansion card holder.

Next steps

1. Install the expansion-card holder.
2. Install the cooling shroud.
3. Follow the procedure listed in [After working inside your system](#).

Related Links

- [Removing the expansion card holder](#)
- [Installing the expansion card holder](#)
- [Removing an expansion card](#)

Removing a GPU card

Prerequisites

△ CAUTION: Many repairs may only be done by a certified service technician. You should only perform troubleshooting and simple repairs as authorized in your product documentation, or as directed by the online or telephone service and support team. Damage due to servicing that is not authorized by Dell is not covered by your warranty. Read and follow the safety instructions that came with the product.

1. Ensure that you read the [Safety instructions](#).
2. Follow the procedure listed in [Before working inside your system](#).
3. Remove the cooling shroud.
4. Remove the expansion-card holder.

Steps

1. Disconnect the cables from the GPU card.

△ CAUTION: Do not use excessive force when removing the cables as it can damage the connectors.

2. Open the two expansion-card latches by pressing the latches.
3. Hold the card by its edge, pull the card up to remove it from the card connector and out of the system.

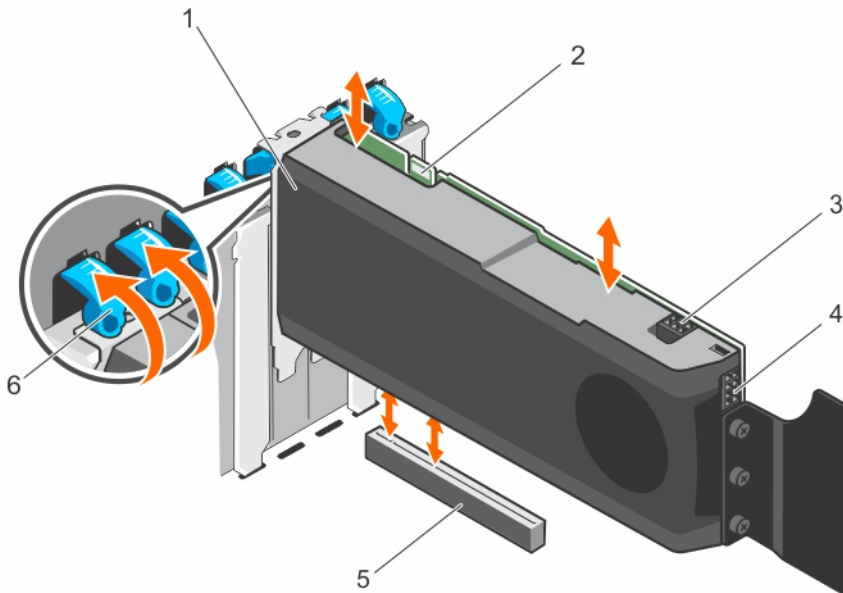



Figure 42. Removing and installing a GPU card

1. GPU card
2. SLI data connector
3. GPU card power connector

4. GPU card power connector
5. x16 connector
6. expansion card latch (2)

Next steps

1. Install the filler brackets by performing the following steps:
 - a. Align the slot on the filler bracket with the guide pin on the expansion card slot.
 - b. Press the expansion card latch until the filler bracket locks into place.
 **NOTE:** Filler brackets must be installed over empty expansion-card slots to maintain FCC certification of the system. The brackets also keep dust and dirt out of the system and aid in proper cooling and airflow inside the system.
2. Close the two expansion card latches.
3. Replace the expansion card holder.
4. Install the cooling shroud.
5. Follow the procedure listed in [After working inside your system](#).

Related Links

- [Removing the cooling shroud](#)
- [Removing the expansion card holder](#)
- [Installing a GPU card](#)

Installing a GPU card

Prerequisites

 **CAUTION:** Many repairs may only be done by a certified service technician. You should only perform troubleshooting and simple repairs as authorized in your product documentation, or as directed by the online or telephone service and support team. Damage due to servicing that is not authorized by Dell is not covered by your warranty. Read and follow the safety instructions that came with the product.

1. Ensure that you read the [Safety instructions](#).
2. Follow the procedure listed in [Before working inside your system](#).
3. Remove the cooling shroud.
4. Remove the expansion card holder.
5. Remove the filler brackets by performing the following steps.
 - a. Open the two expansion card latches.
 - b. Slide the filler brackets out from the system.

 **NOTE:** Keep this bracket in case you need to remove the expansion card. Filler brackets must be installed in empty expansion-card slots to maintain FCC certification of the system. The brackets also keep dust and dirt out of the system and aid in proper cooling and airflow inside the system.

Steps

1. Locate the x16 slot on the system board.
2. Insert the GPU card into the slot.
3. Connect the cables to the GPU card.
4. Close the two expansion card latches.

Next steps

1. Install the expansion card holder.
2. Install the cooling shroud.
3. Follow the procedure listed in [After working inside your system](#).

Related Links

- [Removing the cooling shroud](#)
- [Removing the expansion card holder](#)
- [Installing the expansion card holder](#)
- [Installing the cooling shroud](#)
- [Removing a GPU card](#)

iDRAC ports card (optional)

The iDRAC ports card consists of the SD vFlash card slot and an iDRAC port. The iDRAC ports card is used for advanced management of the system.

An SD vFlash card is a Secure Digital (SD) card that plugs into the SD vFlash card slot in the system. It provides persistent on-demand local storage and a custom deployment environment that allows automation of server configuration, scripts, and imaging. It emulates USB device(s). For more information, see the Integrated Dell Remote Access Controller User's Guide at dell.com/esmmanuals.

Removing the iDRAC ports card

Prerequisites

 **CAUTION:** Many repairs may only be done by a certified service technician. You should only perform troubleshooting and simple repairs as authorized in your product documentation, or as directed by the online or telephone service and support team. Damage due to servicing that is not authorized by Dell is not covered by your warranty. Read and follow the safety instructions that came with the product.

1. Ensure that you read the [Safety instructions](#).
2. Follow the procedure listed in [Before working inside your system](#).
3. Keep the #2 Phillips screwdriver ready.
4. Remove the cooling shroud.
5. Remove the internal cooling fan.

Steps

1. Loosen the two captive screws securing the iDRAC ports card holder to the system board.
2. Pull the iDRAC ports card to disengage it from the connector and remove the card from the chassis.

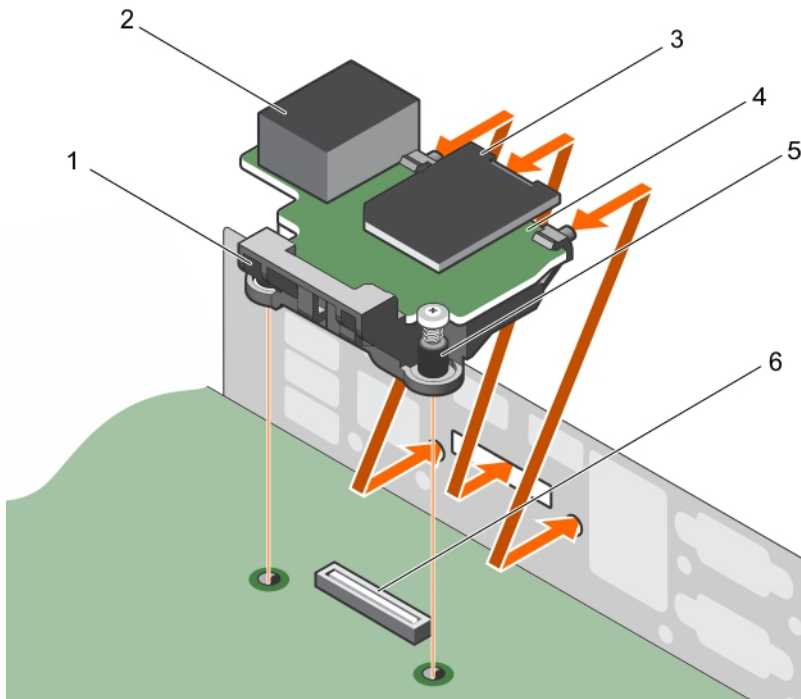

Figure 43. Removing and installing the iDRAC ports card

- | | |
|----------------------------|-------------------------------|
| 1. iDRAC ports card holder | 2. iDRAC port |
| 3. SD vFlash media card | 4. iDRAC ports card |
| 5. captive screw (2) | 6. iDRAC ports card connector |

Related Links

- [Removing the cooling shroud](#)
- [Removing the internal cooling fan](#)
- [Installing the iDRAC ports card](#)

Installing the iDRAC ports card

Prerequisites

⚠ CAUTION: Many repairs may only be done by a certified service technician. You should only perform troubleshooting and simple repairs as authorized in your product documentation, or as directed by the online or telephone service and support team. Damage due to servicing that is not authorized by Dell is not covered by your warranty. Read and follow the safety instructions that came with the product.

1. Ensure that you read the [Safety instructions](#).
2. Follow the procedure listed in [Before working inside your system](#).
3. Keep the #2 Phillips screwdriver ready.
4. Remove the cooling shroud.
5. Remove the internal cooling fan.

Steps

1. Align and insert the tabs on the iDRAC ports card on the slots on the chassis wall.
2. Insert the iDRAC ports card into the connector on the system board.
3. Secure the iDRAC ports card using the two captive screws.

Next steps

1. Install the internal cooling fan.
2. Install the cooling shroud.
3. Follow the procedure listed in [After working inside your system](#).

Related Links

- [Removing the cooling shroud](#)
- [Removing the internal cooling fan](#)
- [Installing the cooling shroud](#)
- [Installing the internal cooling fan](#)
- [Removing the iDRAC ports card](#)

Replacing an SD vFlash media card

1. Locate the SD vFlash media slot at the back of the chassis.
2. To remove the SD vFlash media card, push the card inward to release it, and pull the card from the card slot.

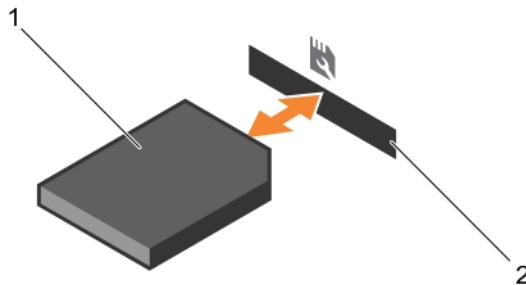



Figure 44. Removing and installing the SD vFlash media card

1. SD vFlash media card
 2. SD vFlash media-card slot
 3. To install an SD vFlash media card, insert the contact-pin end of the SD vFlash media card into the card slot on the module.
-  **NOTE:** The slot is keyed to ensure correct insertion of the card.
4. Press the card inward to lock it into the slot.

Internal dual SD module

The Internal Dual SD Module (IDSDM) card provides two SD card slots. This card offers the following features:

- Dual card operation — maintains a mirrored configuration using SD cards in both slots and provides redundancy.
 - ✎ **NOTE:** When the **Redundancy** option is set to **Mirror Mode** in the **Integrated Devices** screen of System Setup, the information is replicated from one SD card to another.
- Single card operation — single card operation is supported, but without redundancy.

Removing the internal dual SD module

Prerequisites

 **CAUTION:** Many repairs may only be done by a certified service technician. You should only perform troubleshooting and simple repairs as authorized in your product documentation, or as directed by the online or telephone service and support team. Damage due to servicing that is not authorized by Dell is not covered by your warranty. Read and follow the safety instructions that came with the product.

1. Ensure that you read the [Safety instructions](#).
2. Follow the procedure listed in [Before working inside your system](#).
3. Remove the cooling shroud.

Steps

1. Locate the internal dual SD module on the system board.
2. If installed, remove the SD card(s).
3. Hold the plastic pull tab and pull the dual SD module out of the system.

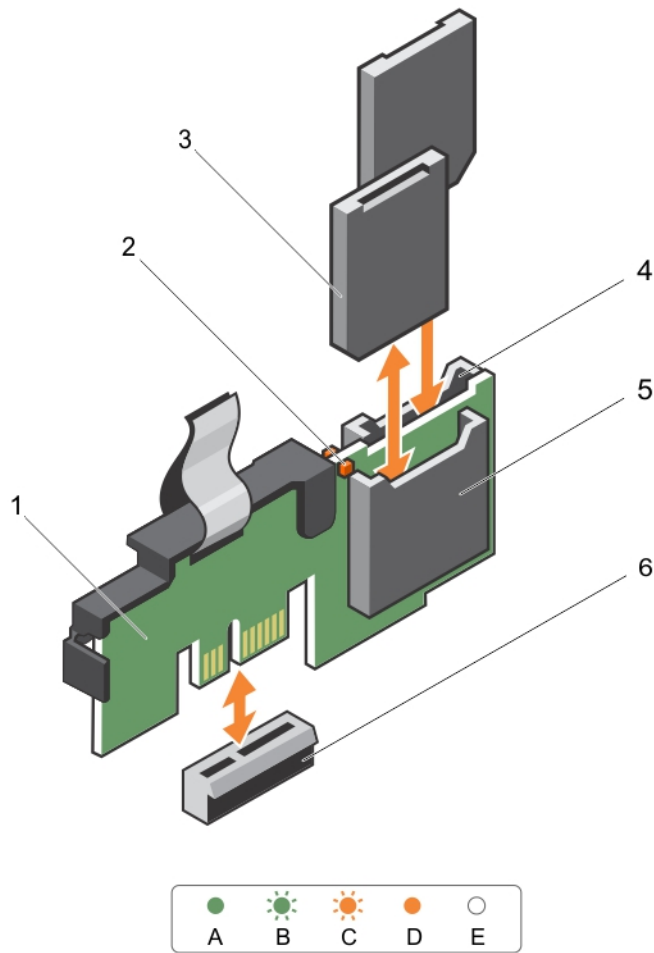

Figure 45. Removing and installing the Internal Dual SD Module (IDSDM)

- | | |
|----------------------------|-----------------------------|
| 1. Internal Dual SD module | 2. LED status indicator (2) |
| 3. SD card (2) | 4. SD card slot 2 |
| 5. SD card slot 1 | 6. IDSDM connector |

The following table describes the IDSDM indicator codes:

Convention	IDSDM indicator code	Condition
A	Green	Indicates that the card is online
B	Flashing green	Indicates rebuild or activity
C	Flashing amber	Indicates card mismatch or that the card has failed
D	Amber	Indicates that the card is offline, has failed, or is write protected

Convention	IDSDM indicator code	Condition
E	Not lit	Indicates that the card is missing or is booting

Next steps

Follow the procedure listed in [After working inside your system](#).

Related Links

- [Removing the cooling shroud](#)
- [Removing an internal SD card](#)
- [Installing the internal dual SD module](#)

Installing the internal dual SD module

Prerequisites

 **CAUTION:** Many repairs may only be done by a certified service technician. You should only perform troubleshooting and simple repairs as authorized in your product documentation, or as directed by the online or telephone service and support team. Damage due to servicing that is not authorized by Dell is not covered by your warranty. Read and follow the safety instructions that came with the product.

1. Ensure that you read the [Safety instructions](#).
2. Follow the procedure listed in [Before working inside your system](#).

Steps

1. Locate the IDSDM connector on the system board.
2. Align the connectors on the system board and the dual SD module.
3. Push the dual SD module until it is firmly seated on the system board.

Next steps

1. Install the SD vFlash media card(s).
2. Install the cooling shroud.
3. Follow the procedure listed in [After working inside your system](#).

Related Links

- [Installing an internal SD card](#)
- [Installing the cooling shroud](#)
- [Removing the internal dual SD module](#)

Internal SD card

Removing an internal SD card

Prerequisites

 **CAUTION:** Many repairs may only be done by a certified service technician. You should only perform troubleshooting and simple repairs as authorized in your product documentation, or as directed by the online or telephone service and support team. Damage due to servicing that is not authorized by Dell is not covered by your warranty. Read and follow the safety instructions that came with the product.

1. Ensure that you read the [Safety instructions](#).
2. Follow the procedure listed in [Before working inside your system](#).
3. Remove the cooling shroud.

Steps

Locate the SD card slot on the internal dual SD module and press the card to release it from the slot.

Next steps

Follow the procedure listed in [After working inside your system](#).

Related Links

[Removing the cooling shroud](#)

[Installing an internal SD card](#)

Installing an internal SD card

Prerequisites



CAUTION: Many repairs may only be done by a certified service technician. You should only perform troubleshooting and simple repairs as authorized in your product documentation, or as directed by the online or telephone service and support team. Damage due to servicing that is not authorized by Dell is not covered by your warranty. Read and follow the safety instructions that came with the product.

1. Ensure that you read the [Safety instructions](#).
2. Follow the procedure listed in [Before working inside your system](#).
3. If installed, remove the cooling shroud.



NOTE: To use an SD card with your system, ensure that the **Internal SD Card Port** is enabled in the System Setup.

Steps

1. Locate the SD card connector on the internal dual SD module. Orient the SD card appropriately and insert the contact-pin end of the card into the slot.



NOTE: The slot is keyed to ensure correct insertion of the card.

2. Press the card into the card slot to lock it into place.

Next steps

1. If removed, replace the cooling shroud.
2. Follow the procedure listed in [After working inside your system](#).

Related Links

[Removing the cooling shroud](#)

[Installing the cooling shroud](#)

[Removing an internal SD card](#)

Processors

Use the following procedure when:

- Installing an additional processor

- Replacing a processor

 **NOTE:** To ensure proper system cooling, you must install a processor blank in any empty processor socket.

Removing a processor

Prerequisites

 **CAUTION:** Many repairs may only be done by a certified service technician. You should only perform troubleshooting and simple repairs as authorized in your product documentation, or as directed by the online or telephone service and support team. Damage due to servicing that is not authorized by Dell is not covered by your warranty. Read and follow the safety instructions that came with the product.

1. Ensure that you read the [Safety instructions](#).
2. Keep the #2 Phillips screwdriver handy.
3. If you are upgrading your system, download the latest system BIOS version from dell.com/support and follow the instructions included in the compressed download file to install the update on your system.

 **NOTE:** You can update the system BIOS using the Lifecycle Controller.

4. Follow the procedure listed in [Before working inside your system](#).
5. Remove the cooling shroud.

 **WARNING:** The heat sink and processor are hot to the touch for some time after the system has been powered down. Allow the heat sink and processor to cool before handling them.

 **CAUTION:** Never remove the heat sink from a processor unless you intend to remove the processor. The heat sink is necessary to maintain proper thermal conditions.

Steps

1. To remove the heat sink:
 - a. Loosen one of the screws that secure the heat sink to the system board.
Wait 30 seconds for the heat sink to loosen from the processor .
 - b. Remove the screw diagonally opposite the screw you first removed.
 - c. Repeat the procedure for the remaining two screws.
 - d. Remove the heat sink.

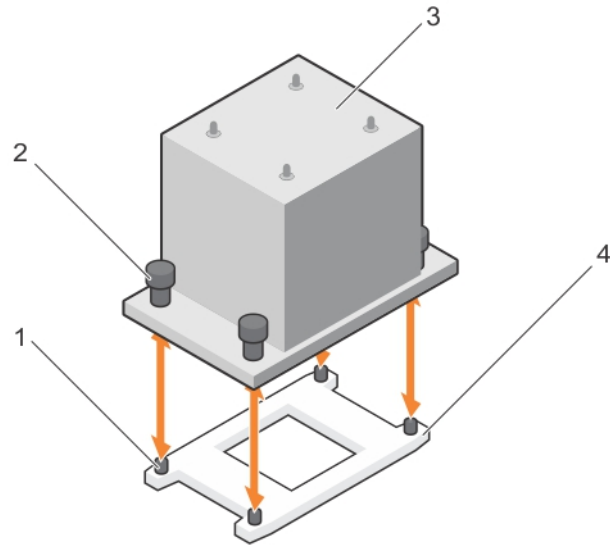

Figure 46. Removing and installing a processor heat sink

- | | |
|--------------|-----------------------|
| 1. slots (4) | 2. captive screws (4) |
| 3. heat sink | 4. processor socket |

⚠ CAUTION: The processor is held in its socket under strong pressure. Be aware that the release lever can spring up suddenly if not firmly grasped.

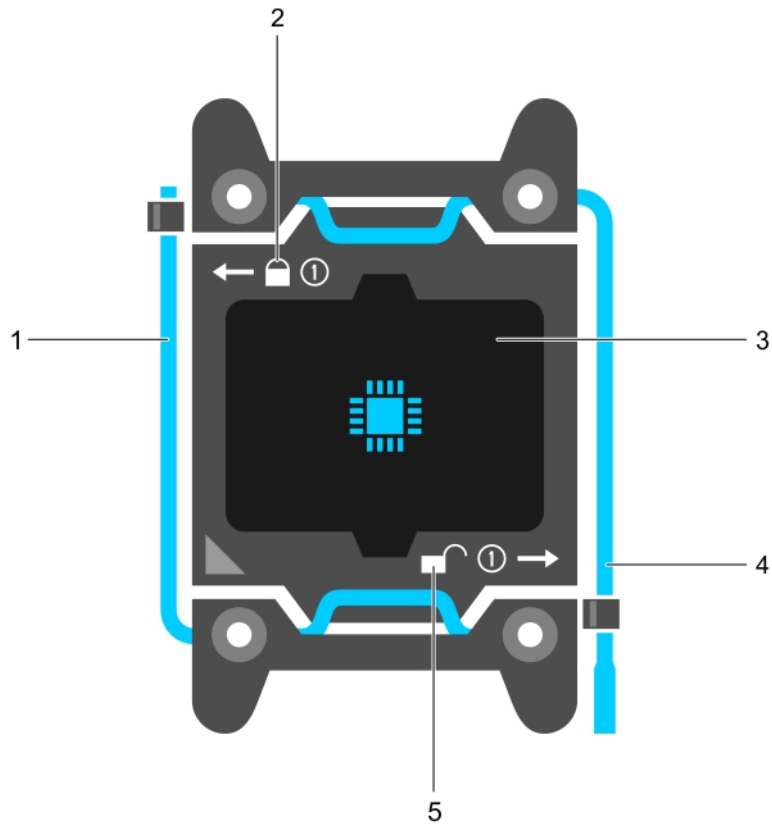



Figure 47. Processor shield

- | | |
|--|---|
| 1. <i>close first</i> socket release lever | 2. lock icon |
| 3. processor | 4. <i>open first</i> socket release lever |
| 5. unlock icon | |

2. To remove the processor:

- Release the *open first* socket-lever near the unlock icon  by pushing the lever down and out from under the tab.
- Similarly, release the *close first* socket-release lever near the lock icon  by pushing the lever down and out from under the tab. Rotate the lever 90 degrees upward.
- Lower the *open first* socket-release lever to lift the processor shield.

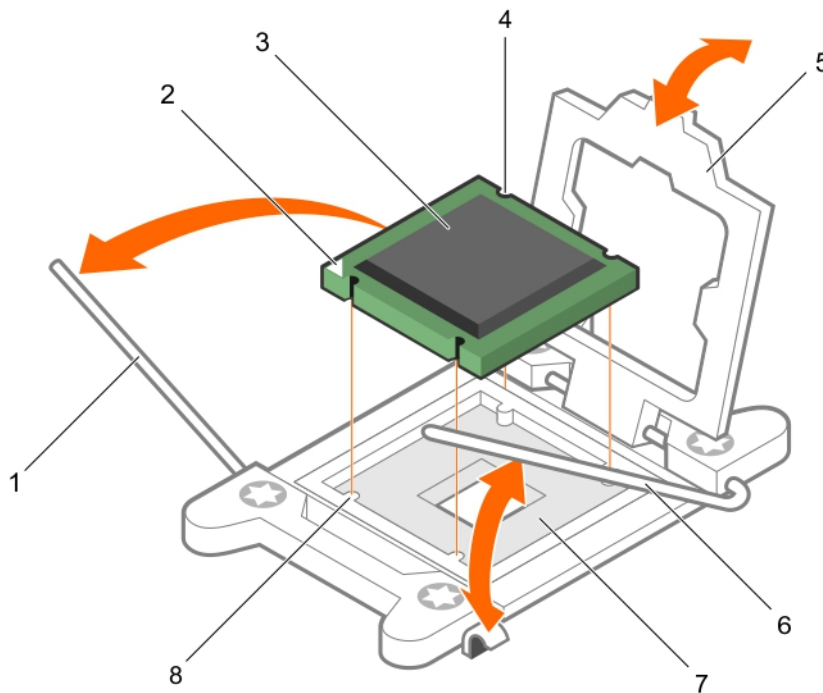

Figure 48. Removing and installing a processor

- | | |
|--|---|
| 1. close <i>first</i> socket-release lever | 2. pin-1 indicator of processor |
| 3. processor | 4. slot (4) |
| 5. processor shield | 6. <i>open first</i> socket-release lever |
| 7. socket | 8. socket keys (4) |

- d. Hold the tab on the processor shield and rotate the processor shield upward until the *open first* socket-release lever lifts up.

⚠ CAUTION: The socket pins are fragile and can be permanently damaged. Be careful not to bend the pins in the socket when removing the processor out of the socket.

- e. Lift the processor out of the socket and leave the *open first* socket-release lever up.

🔧 NOTE: If you are permanently removing the processor, you must install a socket protective cap in the vacant socket to protect the socket pins and keep the socket free of dust.

🔧 NOTE: After removing the processor, place it in an anti-static container for reuse, return, or temporary storage. Do not touch the bottom of the processor. Touch only the side edges of the processor.

Related Links

- [Removing the cooling shroud](#)
- [Installing a processor](#)

Installing a processor

Prerequisites

 **CAUTION:** Many repairs may only be done by a certified service technician. You should only perform troubleshooting and simple repairs as authorized in your product documentation, or as directed by the online or telephone service and support team. Damage due to servicing that is not authorized by Dell is not covered by your warranty. Read and follow the safety instructions that came with the product.

1. Ensure that you read the [Safety instructions](#).
2. Keep the #2 Phillips screwdriver handy.
3. If you are upgrading your system, download the latest system BIOS version from dell.com/support and follow the instructions included in the compressed download file to install the update on your system.

 **NOTE:** You can update the system BIOS using the Lifecycle Controller.



4. Follow the procedure listed in [Before working inside your system](#).
5. Remove the cooling shroud.

 **WARNING:** The heat sink and processor are hot to the touch for some time after the system has been powered down. Allow the heat sink and processor to cool before handling them.

 **CAUTION:** Never remove the heat sink from a processor unless you intend to remove the processor. The heat sink is necessary to maintain proper thermal conditions.

 **NOTE:** If you are installing a single processor, it must be installed in socket CPU1.

Steps

1. Remove the heat sink.
2. Unpack the new processor.
If the processor has previously been used in a system, remove any remaining thermal grease from the processor using a lint-free cloth.
3. Locate the processor socket.
4. If applicable, remove the socket protective cap.
5. Release the *open first* socket-release lever near the unlock icon  by pushing the lever down and out from under the tab.
6. Similarly, release the *close first* socket-release lever near the lock icon  by pushing the lever down and out from under the tab. Lift the lever 90 degrees upward.
7. Hold the tab near the lock symbol on the processor shield and lift it up and out of the way.
8. To install the processor in the socket:

 **CAUTION:** Positioning the processor incorrectly can permanently damage the system board or the processor. Be careful not to bend the pins in the socket.



 **CAUTION:** While removing or reinstalling the processor, wipe your hands of any contaminants. Contaminants on the processor pins such as thermal grease or oil can damage the processor.

- a. Align the processor with the socket keys.

△ CAUTION: Do not use force to seat the processor. When the processor is positioned correctly, it engages easily into the socket.

- b. Align the pin-1 indicator of the processor with the triangle on the system board.
- c. Place the processor on the socket such that the slots on the processor align with the socket keys.

△ CAUTION: Do not use force to seat the processor. When the processor is positioned correctly, it engages easily into the socket.

- d. Close the processor shield.
 - e. Lower the *close first* socket-release lever near the lock icon  and push it under the tab to lock it.
 - f. Similarly, lower the *open first* socket-release lever near the unlock icon  and push it under the tab to lock it.
9. To install the heat sink:
- a. If applicable, remove the existing thermal grease from the heat sink using a clean lint-free cloth.
 - b. Apply thermal grease on the top of the processor. Use the thermal-grease syringe included with your processor kit to apply the grease in a thin spiral on the top of the processor as shown in the figure.

△ CAUTION: Applying too much thermal grease can result in excess grease coming in contact with and contaminating the processor socket.

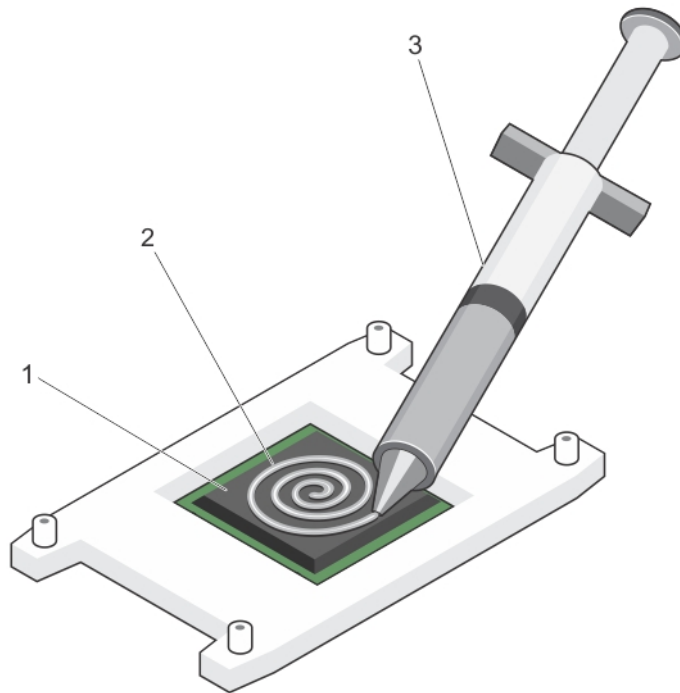



Figure 49. Applying thermal grease on the top of the processor

1. processor

2. thermal grease

3. thermal-grease syringe

 **NOTE:** The thermal-grease is intended for one-time use only. Dispose of the syringe after you use it.

- c. Place the heat sink onto the processor.
- d. Tighten the four screws to secure the heat sink to the system board.

 **NOTE:** Tighten the screws diagonally opposite to each other. Do not over-tighten the heat sink retention screws when installing the heat sink. To prevent over-tightening, tighten the retention screw until resistance is felt, and stop once the screw is seated. The screw tension should be no more than 6 in-lb (6.9 kg-cm).

Next steps

1. Install the cooling shroud.
2. Follow the procedure listed in [After working inside your system](#).
3. While booting, press <F2> to enter the System Setup and check that the processor information matches the new system configuration.
4. Run the system diagnostics to verify that the new processor operates correctly.

Related Links

- [Removing the cooling shroud](#)
- [Installing the cooling shroud](#)
- [Removing a processor](#)

Redundant AC power supply

Your system supports either:

- Two 495 W, 750 W, or 1100 W (Platinum) AC power supply modules or
- Two 450 W (Bronze) AC power supply modules or

 **NOTE:** When two identical power supply units are installed, power supply redundancy (1+1 – with redundancy or 2+0 – without redundancy) is configured in system BIOS. In redundant mode, power is supplied to the system equally from both power supply units when Hot Spare is disabled. When Hot Spare is enabled, one of the power supply units will be put into standby when system utilization is low in order to maximize efficiency.

 **CAUTION:** If two power supplies are used, they must be of the same maximum output power.

 **NOTE:** For AC power supplies, use only power supplies with the Extended Power Performance (EPP) label on the back. Mixing PSUs from previous generations of servers can result in a power supply mismatch condition or failure to power on.

 **NOTE:** When you have more than two GPU cards on your system, you will need two 1100 W power supply units installed on your system.

Hot Spare feature

Your system supports the Hot Spare feature that significantly reduces the power overhead associated with power supply redundancy.

When the Hot Spare feature is enabled, one of the redundant power supplies is switched to a sleep state. The active power supply supports 100% of the load, thus operating at higher efficiency. The power supply

in the sleep state monitors output voltage of the active power supply. If the output voltage of the active power supply drops, the power supply in the sleep state returns to an active output state.

If having both power supplies active is more efficient than having one power supply in a sleep state, the active power supply can also activate a sleeping power supply.

The default power supply settings are as follows:

- If the load on the active power supply is more than 50%, then the redundant power supply is switched to the active state.
- If the load on the active power supply falls below 20%, then the redundant power supply is switched to the sleep state

You can configure the Hot Spare feature using the iDRAC settings. For more information on iDRAC settings, see the Integrated Dell Remote Access Controller User's Guide at dell.com/support/home.

Removing a redundant AC power supply

Prerequisites

 **CAUTION:** Many repairs may only be done by a certified service technician. You should only perform troubleshooting and simple repairs as authorized in your product documentation, or as directed by the online or telephone service and support team. Damage due to servicing that is not authorized by Dell is not covered by your warranty. Read and follow the safety instructions that came with the product.

 **CAUTION:** The system requires one power supply for normal operation. On power-redundant systems, remove and replace only one power supply at a time in a system that is powered on.

1. Ensure that you read the [Safety instructions](#).
2. Disconnect the power cable from the power source and from the power supply unit you intend to remove and remove the cables from the strap.

 **NOTE:** You may have to unlatch and lift the optional cable management arm if it interferes with power supply removal. For information about the cable management arm, see the system's rack documentation.

Steps

Press the release latch and slide the power supply unit out of the chassis.

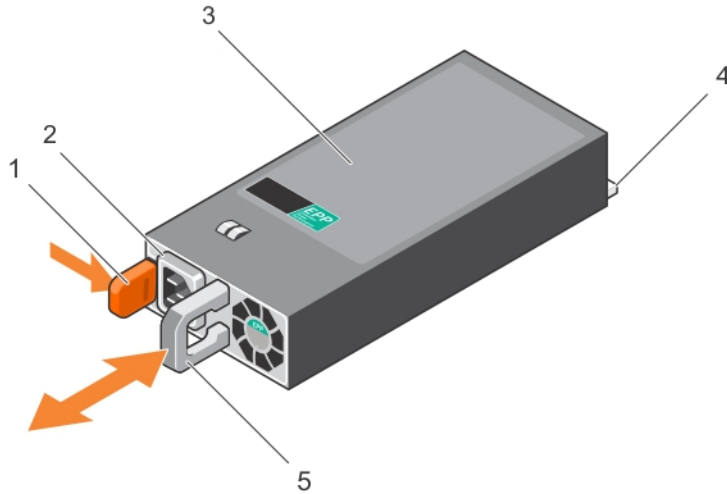

Figure 50. Removing and installing an AC power supply unit

- | | |
|-----------------------------|--------------------------------------|
| 1. release latch | 2. power supply unit cable connector |
| 3. power supply unit | 4. connector |
| 5. power supply unit handle | |

Next steps

If you are not replacing the power supply unit in the second power supply unit bay immediately, install the power supply unit blank in the empty power supply unit bay.

Related Links

- [Installing the power supply unit blank](#)
- [Installing a redundant AC power supply](#)

Installing a redundant AC power supply

Prerequisites

⚠ CAUTION: Many repairs may only be done by a certified service technician. You should only perform troubleshooting and simple repairs as authorized in your product documentation, or as directed by the online or telephone service and support team. Damage due to servicing that is not authorized by Dell is not covered by your warranty. Read and follow the safety instructions that came with the product.

1. Ensure that you read the [Safety instructions](#).
2. Verify that both the power supply units are the same type and have the same maximum output power.

📝 NOTE: The maximum output power (shown in watts) is listed on the power supply label.

3. If installed, remove the power supply unit blank.

Steps

Slide the new power supply unit into the chassis until the power supply unit is fully seated and the release latch snaps into place.

 **NOTE:** If you unlatched the cable management arm, re-latch it. For information about the cable management arm, see the system's rack documentation.

Next steps

1. Connect the power cable to the power supply unit and plug the cable into a power outlet.

 **CAUTION:** When connecting the power cable, secure the cable with the strap.

 **NOTE:** When installing, hot-swapping, or hot-adding a new power supply unit, wait for 15 seconds for the system to recognize the power supply unit and determine its status. The power supply redundancy may not occur until discovery is complete. Wait until the new power supply unit is discovered and enabled before you remove the other power supply unit. The power-supply unit status indicator turns green to signify that the power supply unit is functioning properly.

Related Links

[Removing the power supply unit blank](#)

[Removing a redundant AC power supply](#)

Removing the power supply unit blank

If you are installing a second power supply unit, remove the power supply unit blank in the bay by pulling the blank outward.

 **CAUTION:** To ensure proper system cooling, the power supply blank must be installed in the second power supply bay in a non-redundant configuration. Remove the power supply blank only if you are installing a second power supply.

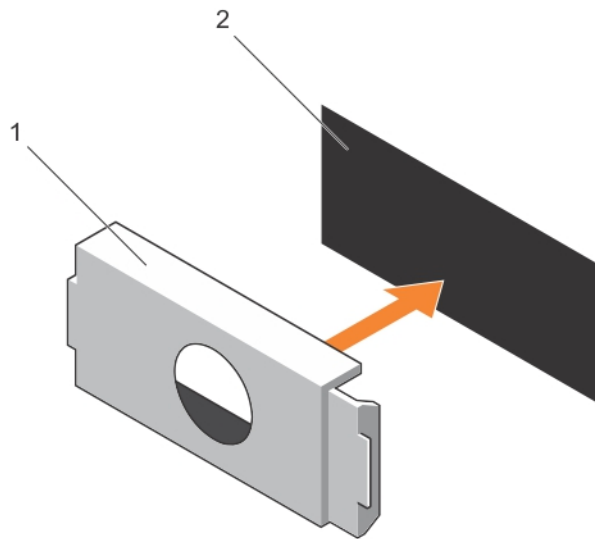

Figure 51. Removing and installing the power supply blank

1. power supply blank

2. power supply bay

Installing the power supply unit blank

Install the power supply unit blank only in the second power supply unit bay.

To install the power supply unit blank, align the blank with the power supply unit bay and push it into the chassis until it clicks into place.

Replacing the power supply divider

Prerequisites

⚠ CAUTION: Many repairs may only be done by a certified service technician. You should only perform troubleshooting and simple repairs as authorized in your product documentation, or as directed by the online or telephone service and support team. Damage due to servicing that is not authorized by Dell is not covered by your warranty. Read and follow the safety instructions that came with the product.

1. Turn off the system, including any attached peripherals, and disconnect the system from the electrical outlet and peripherals.
2. Remove the redundant power supply module(s) or power supply blank as applicable.

Steps

1. Remove the screw securing the power-supply divider to the chassis.
2. Slide out the power-supply divider and turn it clockwise to free the tabs on the power-supply divider from the slots on the power supply unit cage .
3. Slide the power-supply divider out of the chassis.
4. Align the tabs of the new power-supply divider with the slots of the power supply unit cage .
5. Turn the power-supply divider counter-clockwise and slide it in until the power-supply divider is seated on the slots of the power supply unit cage .

- Secure the power supply divider to the chassis using the screw.

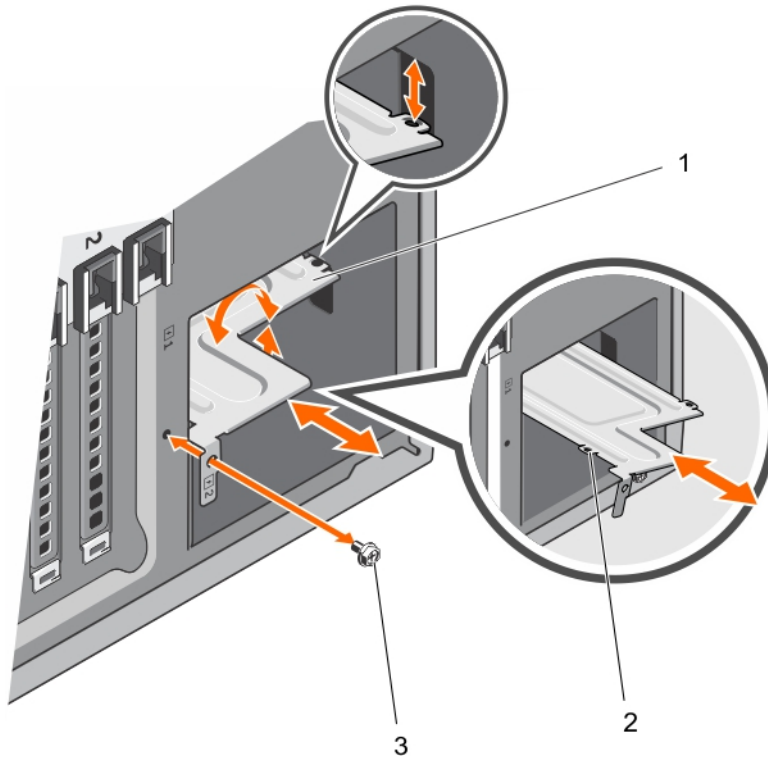

Figure 52. Removing and installing the power-supply divider

- power supply divider
- tabs (4)
- screw

Next steps

- Install the redundant power supply module(s) or power supply blank as applicable.
- Reconnect the system to its electrical outlet and power on the system, including any attached peripherals.

Related Links

[Removing a redundant AC power supply](#)

[Removing the power supply unit blank](#)

[Installing a redundant AC power supply](#)

[Installing the power supply unit blank](#)

Non-redundant AC power supply

Your system supports a non-redundant 450 W AC power supply.

 **NOTE:** Non-redundant power supply is supported in systems with cabled hard drives and systems with an x8 backplane.

 **NOTE:** When selecting or upgrading your system configuration, verify the system power consumption with the Dell Energy Smart Solution Advisor at dell.com/ESSA to ensure optimum power utilization.

Removing a non-redundant AC power supply

Prerequisites

 **CAUTION:** Many repairs may only be done by a certified service technician. You should only perform troubleshooting and simple repairs as authorized in your product documentation, or as directed by the online or telephone service and support team. Damage due to servicing that is not authorized by Dell is not covered by your warranty. Read and follow the safety instructions that came with the product.

1. Ensure that you read the [Safety instructions](#).
2. Follow the procedure listed in [Before working inside your system](#).

Steps

1. Disconnect all the power cables from the power supply to the system board, hard-drive backplane, hard drives, and optical drives.
2. Remove the screw securing the power supply to the chassis and slide the power supply out of the power supply unit cage.

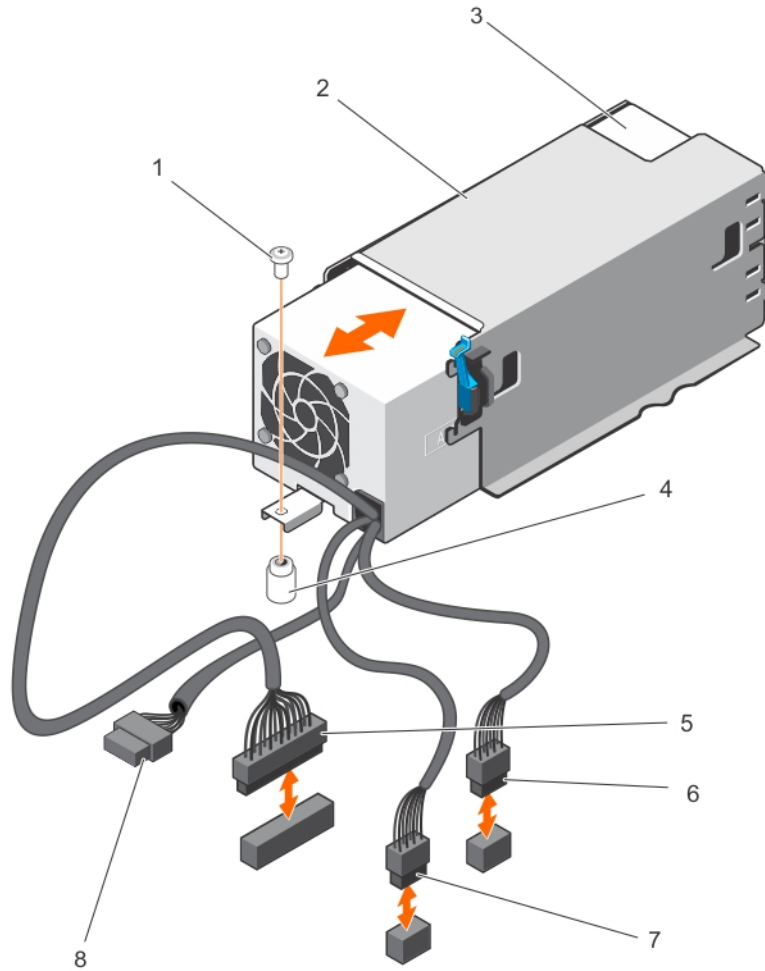

Figure 53. Removing and installing a non-redundant AC power supply

- | | |
|-------------------------------|----------------------------|
| 1. screw | 2. power supply unit cage |
| 3. non-redundant power supply | 4. standoff on the chassis |
| 5. P1 cable connector | 6. P2 cable connector |
| 7. P3 cable connector | 8. backplane connector |

Installing a non-redundant AC power supply

Prerequisites

⚠ CAUTION: Many repairs may only be done by a certified service technician. You should only perform troubleshooting and simple repairs as authorized in your product documentation, or as directed by the online or telephone service and support team. Damage due to servicing that is not authorized by Dell is not covered by your warranty. Read and follow the safety instructions that came with the product.

1. Ensure that you read the [Safety instructions](#).
2. Unpack the new power supply.

Steps

1. Slide the new power supply into the power supply unit cage until the power supply is fully seated.
2. Tighten the screw to secure the power supply to the chassis.
3. Connect all the power cables from the power supply to the system board, hard-drive backplane, hard drives, and optical drives.

Next steps

Follow the procedure listed in [After working inside your system](#).

Power interposer board

The power interposer board is only supported in systems with redundant power supplies.

Removing the power interposer board

Prerequisites

 **CAUTION:** Many repairs may only be done by a certified service technician. You should only perform troubleshooting and simple repairs as authorized in your product documentation, or as directed by the online or telephone service and support team. Damage due to servicing that is not authorized by Dell is not covered by your warranty. Read and follow the safety instructions that came with the product.

1. Ensure that you read the [Safety instructions](#).
2. Follow the procedure listed in [Before working inside your system](#).

 **CAUTION:** To prevent damage to the power interposer board, you must remove the power supply module(s) or power supply blank from the system before removing the power interposer board.

3. Remove the power supply module(s) or power supply blank from the back of the chassis.
4. Remove the cooling shroud.

Steps

1. Disconnect the power cables from the hard-drive backplane and the system board.

 **NOTE:** If installed, remove the expansion card to enable removing the P3 power cable from the system board.

2. Pressing the release latch on the power interposer board (PIB), lift the PIB to release it from the hooks on the power supply unit cage.
3. Lift the PIB up and out of the chassis.

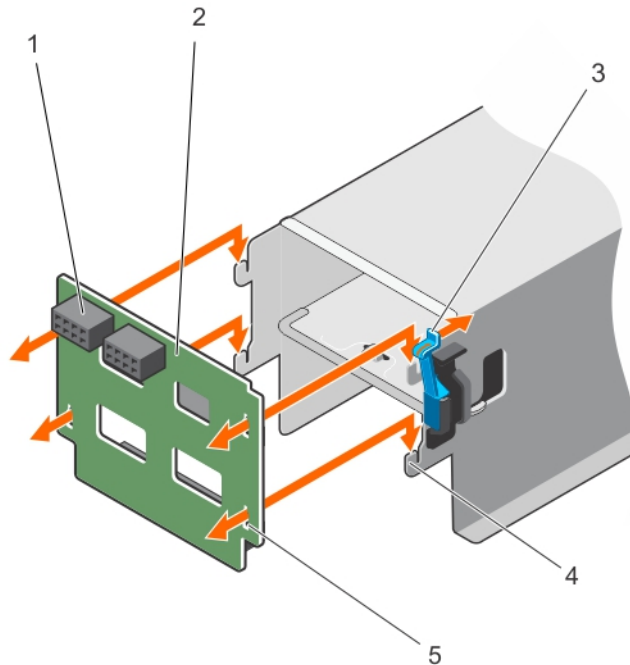

Figure 54. Removing and installing the power interposer board

- | | |
|------------------------|---------------------------|
| 1. GPU power connector | 2. power interposer board |
| 3. release latch | 4. hooks (4) |
| 5. slots (4) | |

Related Links

[Removing a redundant AC power supply](#)

[Removing the cooling shroud](#)

[Installing the power interposer board](#)

Installing the power interposer board

Prerequisites

⚠ CAUTION: Many repairs may only be done by a certified service technician. You should only perform troubleshooting and simple repairs as authorized in your product documentation, or as directed by the online or telephone service and support team. Damage due to servicing that is not authorized by Dell is not covered by your warranty. Read and follow the safety instructions that came with the product.

Ensure that you read the [Safety instructions](#).

Steps

1. Align the slots on the power interposer board (PIB) with the hooks on the power supply cage and slide the PIB until it snaps into place.
2. Route the power cables through the securing clips as applicable, and connect the power cables to the system board.
3. Route the P3 power cable through the securing clip on the system board and connect power cable to the hard-drive backplane.

Next steps

1. Install the cooling shroud.
2. Install the power supply module(s) or power supply blank in their original locations.
3. Follow the procedure listed in [After working inside your system](#).

Related Links

- [Installing the cooling shroud](#)
- [Installing a redundant AC power supply](#)
- [Removing the power interposer board](#)

System battery

Replacing the system battery

Prerequisites

 **CAUTION:** Many repairs may only be done by a certified service technician. You should only perform troubleshooting and simple repairs as authorized in your product documentation, or as directed by the online or telephone service and support team. Damage due to servicing that is not authorized by Dell is not covered by your warranty. Read and follow the safety instructions that came with the product.

1. Ensure that you read the [Safety instructions](#).
2. Follow the procedure listed in [Before working inside your system](#).
3. Remove the cooling shroud.

 **WARNING:** There is a danger of a new battery exploding if it is incorrectly installed. Replace the battery only with the same or equivalent type recommended by the manufacturer. See your safety information for additional information.

Steps

1. Locate the battery socket. For more information, see [System board connectors](#).

 **CAUTION:** To avoid damage to the battery connector, you must firmly support the connector while installing or removing a battery.

2. To eject the battery, press firmly on the edge of the positive side of the battery in the direction of the arrow as shown in the illustration below.

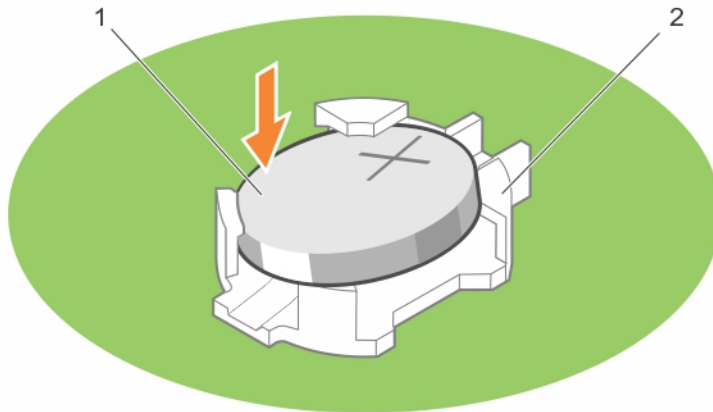

Figure 55. Removing and installing the system battery

1. positive side of battery
2. socket
3. To install a new system battery, hold the battery with the positive facing up and slide it under the securing tabs.
4. Press the battery into the connector until it snaps into place.

Next steps

1. Install the cooling shroud.
2. Follow the procedure listed in [After working inside your system](#).
3. While booting, press <F2> to enter the System Setup and ensure the battery is operating properly.
4. Enter the correct time and date in the System Setup **Time** and **Date** fields.
5. Exit the System Setup.

Related Links

- [Removing the cooling shroud](#)
- [Installing the cooling shroud](#)

Control panel assembly

Removing the control panel assembly

Prerequisites

CAUTION: Many repairs may only be done by a certified service technician. You should only perform troubleshooting and simple repairs as authorized in your product documentation, or as directed by the online or telephone service and support team. Damage due to servicing that is not authorized by Dell is not covered by your warranty. Read and follow the safety instructions that came with the product.

1. Ensure that you read the [Safety instructions](#).
2. Keep the #2 Phillips screwdriver ready.

3. Follow the procedure listed in [Before working inside your system.](#)

Steps

1. Remove the screw securing the control panel to the chassis.
2. Disconnect the control panel cable and the control panel USB cable from the system board.

⚠ CAUTION: Do not use excessive force when removing the control panel cables as it can damage the connectors.

3. Slide the control panel out of the chassis.
4. Disconnect the cables from the control panel.

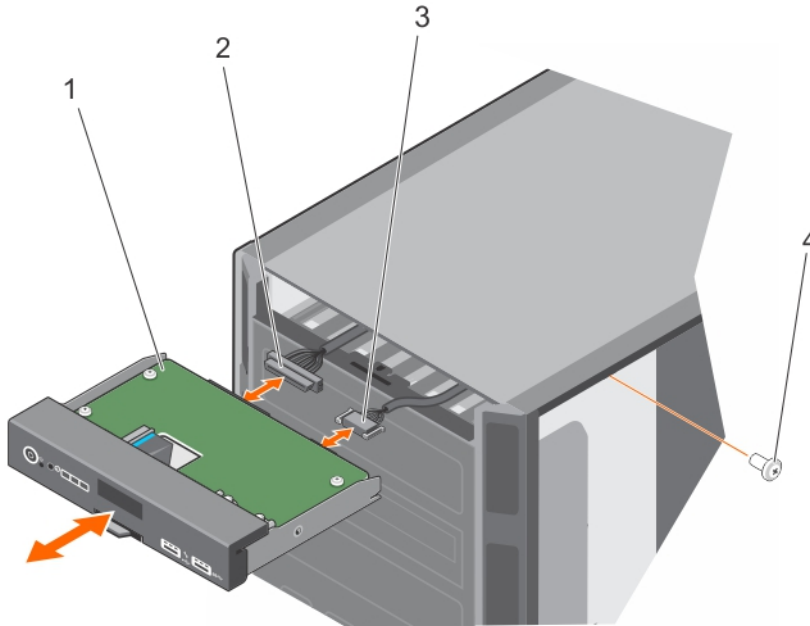

Figure 56. Removing and installing the control panel assembly

- | | |
|----------------------------|------------------------|
| 1. control panel | 2. control panel cable |
| 3. control panel USB cable | 4. screw |

🔧 NOTE: Follow the same steps to remove the control panel in the rack-mode configuration.

5. Locate and press the tabs on the information tag.
6. Push the information tag out of the slot to remove it from the control panel.

🔧 NOTE: Retain the information tag to replace it in the new control panel.

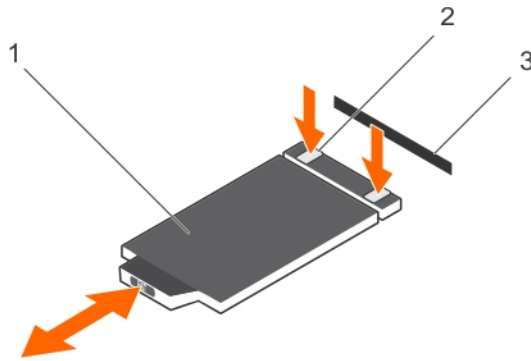

Figure 57. Removing and installing the information tag

1. information tag
2. tab (2)
3. slot

Related Links

[Preparing a system for conversion from tower mode to rack mode](#)

[Installing the control panel assembly](#)

Installing the control panel assembly

Prerequisites

CAUTION: Many repairs may only be done by a certified service technician. You should only perform troubleshooting and simple repairs as authorized in your product documentation, or as directed by the online or telephone service and support team. Damage due to servicing that is not authorized by Dell is not covered by your warranty. Read and follow the safety instructions that came with the product.

1. Ensure that you read the [Safety instructions](#).
2. Keep the #2 Phillips screwdriver ready.

Steps

1. Replace the blank information tag in the new control panel with the information tag retained from the old control panel.
 - NOTE:** Information tag lists system information such as Service Tag, NIC, MAC address, and so on.
2. To install the information tag, push the information tag into the control-panel slot.
3. Connect the control panel cable and the control panel USB cable to the control panel module.
4. Align and insert the control panel into the control panel slot in the chassis.
5. Secure the control panel to the chassis using the screw.
6. Connect the control panel cable and the control panel USB cable to the system board.

Next steps

1. Follow the procedure listed in [After working inside your system](#).

Related Links

- [Preparing a system for conversion from tower mode to rack mode](#)
- [Removing the control panel assembly](#)

Removing the control panel assembly cover

Prerequisites

CAUTION: Many repairs may only be done by a certified service technician. You should only perform troubleshooting and simple repairs as authorized in your product documentation, or as directed by the online or telephone service and support team. Damage due to servicing that is not authorized by Dell is not covered by your warranty. Read and follow the safety instructions that came with the product.

1. Ensure that you read the [Safety instructions](#).
2. Follow the procedure listed in [Before working inside your system](#).
3. Remove the control panel assembly.

Steps

1. Unhook the tab adjacent to the power button.
2. Unhook the tab on the bottom of the control panel assembly cover.
3. Pull the control panel assembly cover to detach it from the control panel.

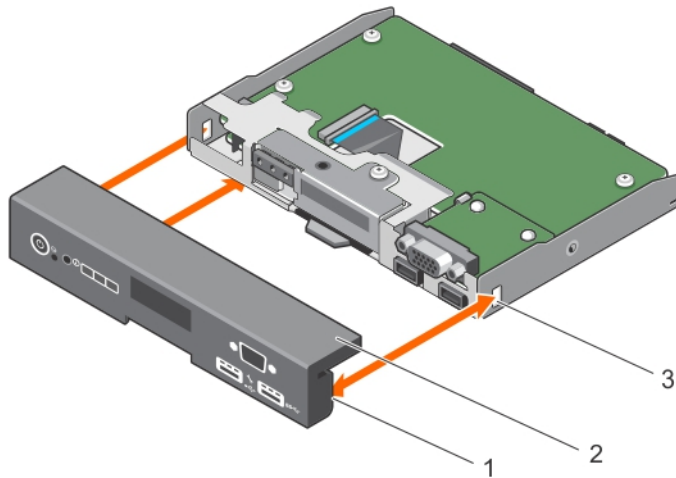

Figure 58. Removing and installing the control panel assembly cover for system with LCD panel

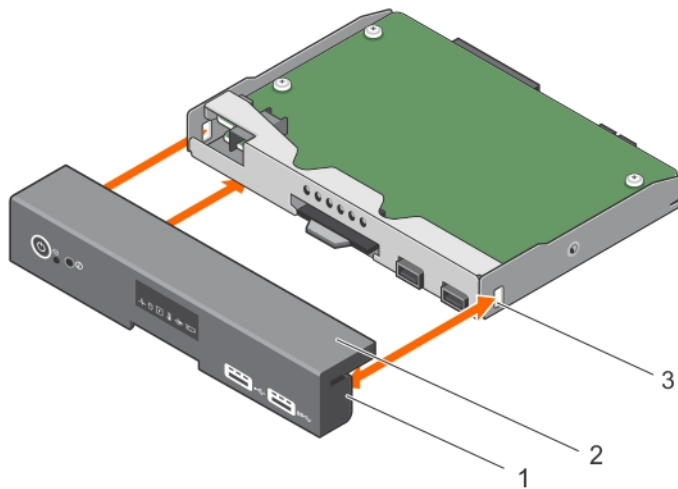

Figure 59. Removing and installing the control panel assembly cover for system with LED panel

1. tab (3)
2. control panel assembly cover
3. slot (3)

Related Links

[Removing the control panel assembly](#)

[Preparing a system for conversion from tower mode to rack mode](#)

[Installing the control panel assembly cover](#)

Installing the control panel assembly cover

Prerequisites

⚠ CAUTION: Many repairs may only be done by a certified service technician. You should only perform troubleshooting and simple repairs as authorized in your product documentation, or as directed by the online or telephone service and support team. Damage due to servicing that is not authorized by Dell is not covered by your warranty. Read and follow the safety instructions that came with the product.

Ensure that you read the [Safety instructions](#).

Steps

1. Align the three tabs on the control panel assembly cover with the slots on the control panel.
2. Push the cover until the tabs lock into place.

Next steps

1. Install the control panel assembly.
2. Follow the procedure listed in [After working inside your system](#).

Related Links

[Installing the control panel assembly](#)

[Preparing a system for conversion from tower mode to rack mode](#)

[Removing the control panel assembly cover](#)

Removing the control-panel board

Prerequisites

CAUTION: Many repairs may only be done by a certified service technician. You should only perform troubleshooting and simple repairs as authorized in your product documentation, or as directed by the online or telephone service and support team. Damage due to servicing that is not authorized by Dell is not covered by your warranty. Read and follow the safety instructions that came with the product.

1. Ensure that you read the [Safety instructions](#).
2. Keep the #2 Phillips screwdriver ready.
3. Follow the procedure listed in [Before working inside your system](#).
4. Remove the control panel assembly.
5. Remove the control panel assembly cover.

Steps

1. Remove the screws securing the control-panel board to the control panel.
2. Lift the control-panel board until the control-panel board disengages from the slots on the control panel.
3. Slide the control-panel board toward the back of the control panel and lift the control-panel board away from the control panel.

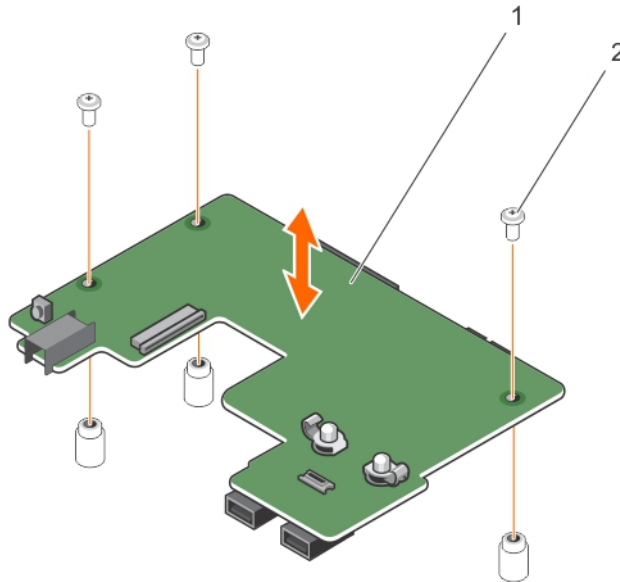

Figure 60. Removing and installing the control-panel board for systems with hot-swappable hard drives

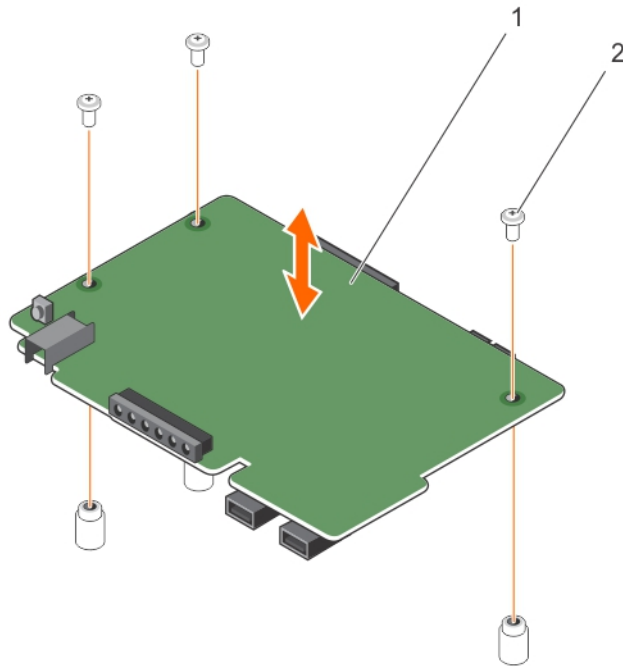

Figure 61. Removing and installing the control-panel board for systems with cabled hard drives

1. control-panel board
2. screw (3)

Related Links

[Installing the control-panel board](#)

Installing the control-panel board

Prerequisites

⚠ CAUTION: Many repairs may only be done by a certified service technician. You should only perform troubleshooting and simple repairs as authorized in your product documentation, or as directed by the online or telephone service and support team. Damage due to servicing that is not authorized by Dell is not covered by your warranty. Read and follow the safety instructions that came with the product.

1. Ensure that you read the [Safety instructions](#).
2. Keep the #2 Phillips screwdriver ready.

Steps

1. Align the control-panel board with the control panel.

⚠ CAUTION: Take care not to damage the mylar covering the ID switch.

2. Slide the control-panel board toward the front of the control panel to lock the slide tabs and screw holes into the respective slots on the control panel.
3. Install the three screws to secure the control-panel board to the control panel.

Next steps

1. Install the control-panel assembly cover.
2. Install the control panel assembly.
3. Follow the procedure listed in [After working inside your system](#).

Related Links

[Installing the control panel assembly cover](#)

[Installing the control panel assembly](#)

[Removing the control-panel board](#)

Removing the LCD module

Prerequisites



CAUTION: Many repairs may only be done by a certified service technician. You should only perform troubleshooting and simple repairs as authorized in your product documentation, or as directed by the online or telephone service and support team. Damage due to servicing that is not authorized by Dell is not covered by your warranty. Read and follow the safety instructions that came with the product.

1. Ensure that you read the [Safety instructions](#).
2. Keep the #2 Phillips screwdriver ready.
3. Follow the procedure listed in [Before working inside your system](#).
4. Remove the control-panel assembly.
5. Remove the control panel assembly cover.

Steps

1. Disconnect the LCD cable. Perform the following steps to disconnect the LCD cable:
 - a. Pull the retention tab that secures the LCD cable to the LCD cable connector on the control panel board.
 - b. Pull the LCD cable out of the LCD cable connector.
2. Remove the screw securing the LCD module to the control panel.
3. Remove the LCD module out of the control panel assembly.

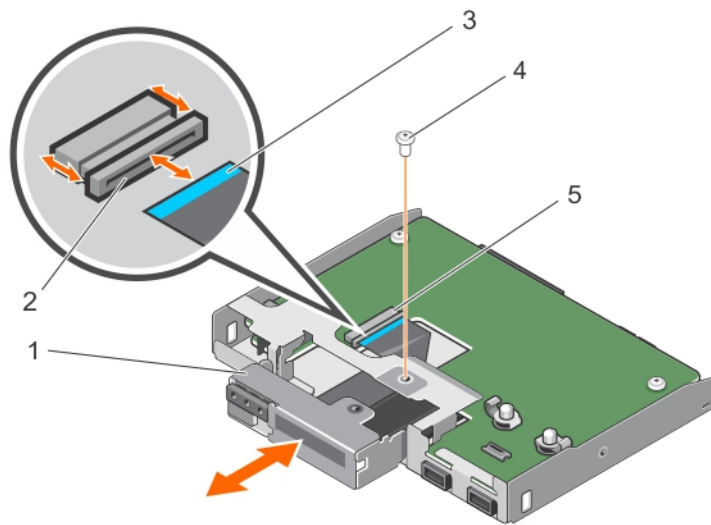

Figure 62. Removing and Installing the LCD Module

- | | |
|------------------------|------------------|
| 1. LCD module | 2. retention tab |
| 3. LCD cable | 4. screw |
| 5. LCD cable connector | |

Related Links

[Removing the control panel assembly](#)

[Removing the control panel assembly cover](#)

[Installing the LCD module](#)

Installing the LCD module

Prerequisites

⚠ CAUTION: Many repairs may only be done by a certified service technician. You should only perform troubleshooting and simple repairs as authorized in your product documentation, or as directed by the online or telephone service and support team. Damage due to servicing that is not authorized by Dell is not covered by your warranty. Read and follow the safety instructions that came with the product.

1. Ensure that you read the [Safety instructions](#).
2. Keep the #2 Phillips screwdriver ready.

Steps

1. Align the LCD module with the LCD module slot and insert the LCD module into the control panel.
2. Secure the LCD module to the control panel using the screw.

Next steps

1. Install the control panel assembly cover.
2. Connect the LCD cable, the control panel cable and the control panel USB cable to the control panel board.

3. Install the control panel assembly.
4. Connect the control panel cable, the LCD cable and the control panel USB cable to the system board.
5. Follow the procedure listed in [After working inside your system](#).

Related Links

- [Installing the control panel assembly cover](#)
- [Installing the control panel assembly](#)
- [Removing the LCD module](#)

Removing the VGA module

Prerequisites

△ CAUTION: Many repairs may only be done by a certified service technician. You should only perform troubleshooting and simple repairs as authorized in your product documentation, or as directed by the online or telephone service and support team. Damage due to servicing that is not authorized by Dell is not covered by your warranty. Read and follow the safety instructions that came with the product.

1. Ensure that you read the [Safety instructions](#).
2. Follow the procedure listed in [Before working inside your system](#).
3. Remove the control panel assembly.
4. Remove the control panel assembly cover.

Steps

Release the hooks securing the VGA module to the control panel board and remove the VGA module.

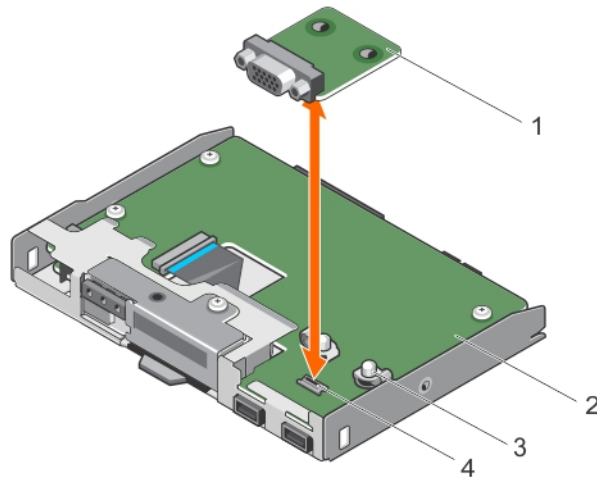

Figure 63. Removing and installing the VGA module

- | | |
|---------------|---|
| 1. VGA module | 2. control panel |
| 3. hook (2) | 4. VGA connector on the control panel board |

Related Links

- [Removing the control panel assembly](#)

[Removing the control panel assembly cover](#)

[Installing the VGA module](#)

Installing the VGA module

Prerequisites

 **CAUTION:** Many repairs may only be done by a certified service technician. You should only perform troubleshooting and simple repairs as authorized in your product documentation, or as directed by the online or telephone service and support team. Damage due to servicing that is not authorized by Dell is not covered by your warranty. Read and follow the safety instructions that came with the product.

Ensure that you read the [Safety instructions](#).

Steps

1. Align the slots on the VGA module with the VGA connector and hooks on the control panel board.
2. Press down on the VGA module until the hooks snap into place.
3. Install the control panel assembly cover.
4. Install the control panel.

Next steps

1. Install the control panel assembly cover.
2. Install the control panel assembly.
3. Follow the procedure listed in [After working inside your system](#).

Related Links

[Installing the control panel assembly cover](#)

[Installing the control panel assembly](#)

[Preparing a system for conversion from tower mode to rack mode](#)

[Removing the VGA module](#)

System board

Removing the system board

Prerequisites

 **CAUTION:** Many repairs may only be done by a certified service technician. You should only perform troubleshooting and simple repairs as authorized in your product documentation, or as directed by the online or telephone service and support team. Damage due to servicing that is not authorized by Dell is not covered by your warranty. Read and follow the safety instructions that came with the product.

1. Ensure that you read the [Safety instructions](#).
2. Keep the #2 Phillips screwdriver ready.
3. Follow the procedure listed in [Before working inside your system](#).

 **CAUTION:** If you are using the Trusted Program Module (TPM) with an encryption key, you may be prompted to create a recovery key during program or System Setup. Be sure to create and safely store this recovery key. If you replace this system board, you must supply the recovery key when you restart your system or program before you can access the encrypted data on your hard drives.

 **CAUTION:** Do not attempt to remove the TPM plug-in module from the motherboard. Once the TPM plug-in module is installed, it is cryptographically bound to that specific motherboard. Any attempt to remove an installed TPM plug-in module breaks the cryptographic binding, and it cannot be re-installed or installed on another motherboard.

4. Remove the following:
 - a. expansion card holder
 - b. cooling shroud
 - c. internal dual SD module
 - d. internal USB key (if installed)
 - e. internal cooling fan
 - f. iDRAC ports card (if installed)
 - g. heat sink(s)
 - h. processors(s)
 -  **CAUTION:** To prevent damage to the processor pins when replacing a faulty system board, ensure that you cover the processor socket with the processor protective cap.
 - i. memory modules

Steps

1. Disconnect all cables from the system board.

 **CAUTION:** Take care not to damage the system identification button while removing the system board from the chassis.

2. Remove the screws that secure the system board to the chassis.

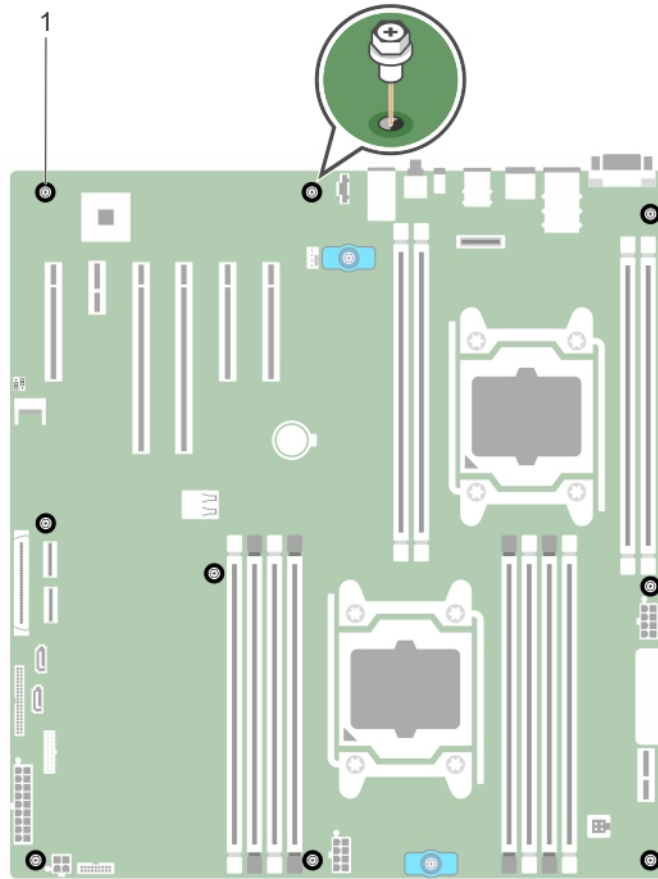

Figure 64. Removing and installing the screws on the system board

1. screws (9)

CAUTION: Do not lift the system board assembly by holding a memory module, processor, or other components.

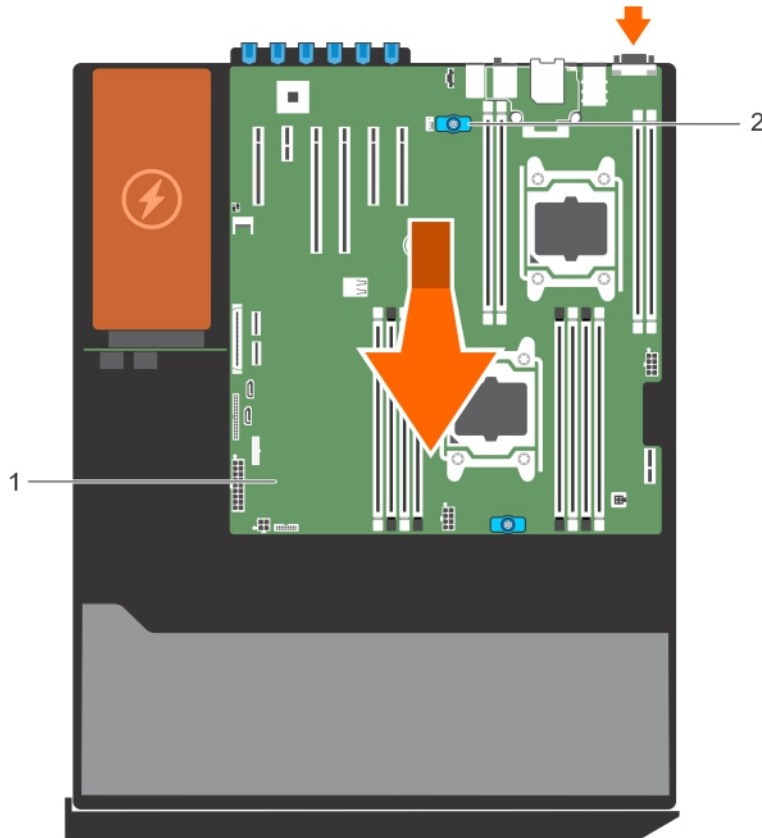

Figure 65. Removing the system board

1. system board
2. t-handle posts (2)
3. Hold the t-handle posts and slide the system board toward the front of the system.
4. Hold the t-handle posts and lift the system board out of the chassis.

Related Links

- [Removing the expansion card holder](#)
- [Removing the cooling shroud](#)
- [Removing the internal dual SD module](#)
- [Removing the internal cooling fan](#)
- [Removing the iDRAC ports card](#)
- [Removing a processor](#)
- [Removing memory modules](#)
- [Installing the system board](#)

Installing the system board

Prerequisites

 **CAUTION:** Many repairs may only be done by a certified service technician. You should only perform troubleshooting and simple repairs as authorized in your product documentation, or as directed by the online or telephone service and support team. Damage due to servicing that is not authorized by Dell is not covered by your warranty. Read and follow the safety instructions that came with the product.

1. Ensure that you read the [Safety instructions](#).
2. Keep the #2 Phillips screwdriver ready.
3. Follow the procedure listed in [Before working inside your system](#).

Steps

1. Unpack the new system board assembly.

 **CAUTION:** Do not lift the system board assembly by holding a memory module, processor, or other components.

2. Hold the posts and lower the system board into the chassis.
3. Push the system board toward the back of the chassis such that the ports on the system board align with the corresponding slots on the chassis.
4. Install the screws to secure the system board to the chassis.

Next steps

1. Install the Trusted Platform Module (TPM). For information on how to install TPM, see [Installing the Trusted Platform Module](#). For information on TPM, see [Trusted Platform Module](#).
2. Replace the following:
 - a. processors(s) and heat sink(s)
 - b. internal USB key (if required)
 - c. internal dual SD module
 - d. cooling shroud
 - e. internal cooling fan
 - f. expansion card holder
 - g. iDRAC ports card
3. Reconnect all cables to the system board.

 **NOTE:** Ensure that the cables inside the system are routed along the chassis wall and secured using the cable securing bracket.
4. Follow the procedure listed in [After working inside your system](#).
5. Ensure that you:
 - a. Use the **Easy Restore** feature to restore the service tag. For more information, see [Easy Restore](#).
 - b. If the service tag is not backed up in the backup flash device, enter the system service tag manually. For more information, see [Entering the system service tag](#).
 - c. Update the BIOS and iDRAC versions.
 - d. Re-enable the Trusted Platform Module (TPM). For more information, see [Re-enabling the TPM for BitLocker users](#) or [Re-enabling the TPM for TXT users](#).

Related Links

[Installing a processor](#)

- [Installing the internal dual SD module](#)
- [Installing the cooling shroud](#)
- [Installing the internal cooling fan](#)
- [Installing the expansion card holder](#)
- [Installing the iDRAC ports card](#)
- [Removing the system board](#)

Restoring the Service Tag using Easy Restore

Use the Easy Restore feature if you do not know the Service Tag of your system. The Easy Restore feature allows you to restore your system's Service Tag, license, UEFI configuration, and the system configuration data after replacing the system board. All data is backed up in a backup flash device automatically. If BIOS detects a new system board and the Service Tag in the backup flash device, BIOS prompts the user to restore the backup information.

1. Turn on the system.
If BIOS detects a new system board, and if the Service Tag is present in the backup flash device, BIOS displays the Service Tag, the status of the license, and the **UEFI Diagnostics** version.
2. Do one of the following:
 - Press **Y** to restore the Service Tag, license, and diagnostics information.
 - Press **N** to navigate to the Lifecycle Controller based restore options.
 - Press <F10> to restore data from a previously created **Hardware Server Profile**.

After the restore process is complete, BIOS prompts to restore the system configuration data.

3. Do one of the following:
 - Press **Y** to restore the system configuration data.
 - Press **N** to use the default configuration settings.

After the restore process is complete, the system restarts.

Entering the system Service Tag using System Setup

If you know the system Service Tag, use the System Setup menu to enter the Service Tag.

1. Turn on the system.
2. Press <F2> to enter the System Setup.
3. Click **Service Tag Settings**.
4. Enter the Service Tag.



NOTE: You can enter the only when the **Service Tag** field is empty. Ensure that you enter the correct Service Tag. Once the Service Tag is entered, it cannot be updated or changed.

5. Click **Ok**.
6. Import your new or existing iDRAC Enterprise license.

For more information, see Integrated Dell Remote Access Controller User's Guide, at dell.com/esmanuals.

Trusted Platform Module

The Trusted Platform Module (TPM) is used to generate/store keys, protect/authenticate passwords, and create/store digital certificates. TPM can also be used to enable the BitLocker hard drive encryption feature in Windows Server.

 **CAUTION:** Do not attempt to remove the Trusted Platform Module (TPM) from the system board. Once the TPM is installed, it is cryptographically bound to that specific system board. Any attempt to remove an installed TPM breaks the cryptographic binding, and it cannot be re-installed or installed on another system board.

Installing the Trusted Platform Module

Prerequisites

 **CAUTION:** Many repairs may only be done by a certified service technician. You should only perform troubleshooting and simple repairs as authorized in your product documentation, or as directed by the online or telephone service and support team. Damage due to servicing that is not authorized by Dell is not covered by your warranty. Read and follow the safety instructions that came with the product.

Ensure that you read the [Safety instructions](#).

Steps

1. Align the edge connectors on the TPM with the slot on the TPM connector.
2. Insert the TPM into the TPM connector such that the plastic bolt aligns with the slot on the system board.
3. Press the plastic bolt until the bolt snaps into place.

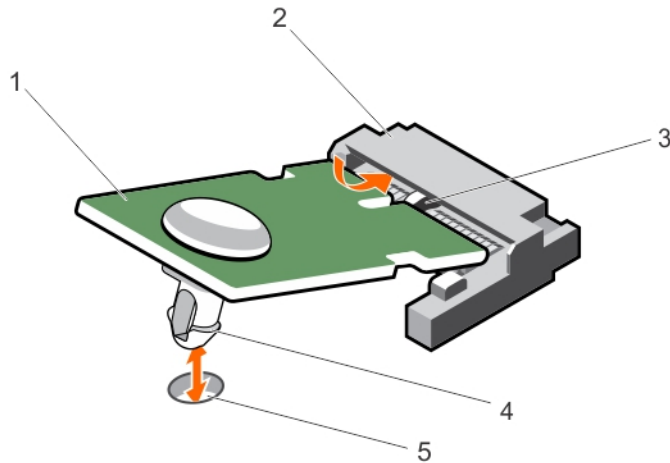

Figure 66. Installing the TPM

- | | |
|------------------------------|------------------|
| 1. TPM | 2. TPM connector |
| 3. slot on the TPM connector | 4. plastic bolt |
| 5. slot on the system board | |

Re-enabling the TPM for BitLocker users

Initialize the TPM.

For more information on initializing the TPM, see <http://technet.microsoft.com/en-us/library/cc753140.aspx>.

The **TPM Status** changes to **Enabled, Activated**.

Re-enabling the TPM for TXT users

1. While booting your system, press <F2> to enter System Setup.
2. In the **System Setup Main Menu**, click **System BIOS** → **System Security Settings**.
3. In the **TPM Security** option, select **On with Pre-boot Measurements**.
4. In the **TPM Command** option, select **Activate**.
5. Save the settings.
6. Restart your system.
7. Enter System Setup again.
8. In the **System Setup Main Menu**, click **System BIOS** → **System Security Settings**.
9. In the **Intel TXT** option, select **On**.

System top cover

Do not remove the system top cover unless you are converting the system from tower to rack mode.

Removing the system top cover

Prerequisites

△ CAUTION: Many repairs may only be done by a certified service technician. You should only perform troubleshooting and simple repairs as authorized in your product documentation, or as directed by the online or telephone service and support team. Damage due to servicing that is not authorized by Dell is not covered by your warranty. Read and follow the safety instructions that came with the product.

1. Ensure that you read the [Safety instructions](#).
2. Keep the #2 Phillips screwdriver ready.
3. Turn off the system, including any attached peripherals, and disconnect the system from the electrical outlet and peripherals.
4. Remove the system cover.

Steps

1. Remove the screws that secure the top cover to the chassis.
2. Slide the cover toward the back of the system and lift it from the system.

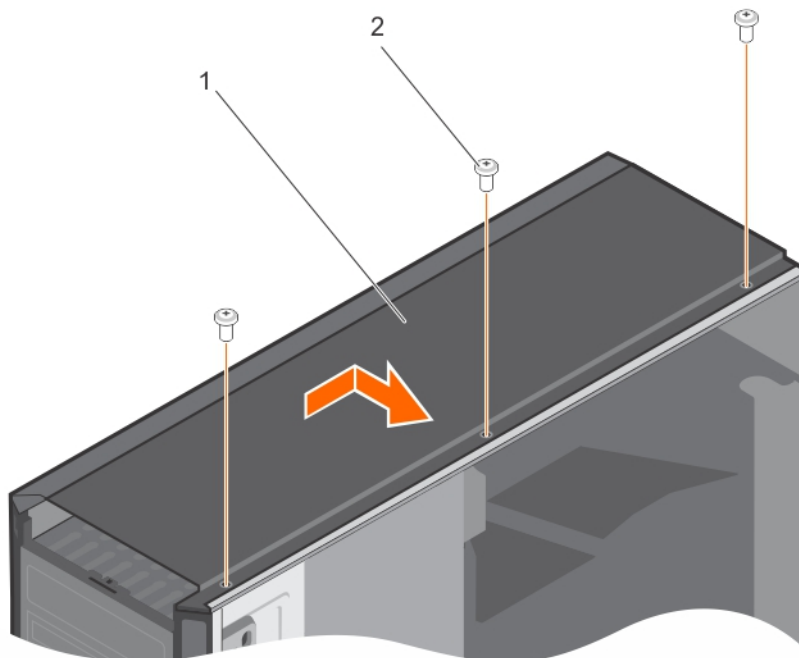

Figure 67. Removing the installing the system top cover

1. system top cover

2. screw (3)

Related Links

[Removing the system cover](#)

[Installing the system top cover](#)

[Preparing a system for conversion from tower mode to rack mode](#)

Installing the system top cover

Prerequisites



CAUTION: Many repairs may only be done by a certified service technician. You should only perform troubleshooting and simple repairs as authorized in your product documentation, or as directed by the online or telephone service and support team. Damage due to servicing that is not authorized by Dell is not covered by your warranty. Read and follow the safety instructions that came with the product.

1. Ensure that you read the [Safety instructions](#).
2. Keep the #2 Phillips screwdriver ready.

Steps

1. Align the tabs under the top cover with the slots on the top of the chassis.
2. Slide the cover toward the front of the system until the screw holes on the cover aligns with the holes on the chassis.
3. Secure the cover onto the chassis using the screws.

Next steps

1. Install the system cover.
2. Reconnect the system to its electrical outlet and turn the system on, including any attached peripherals.

Converting the system from tower mode to rack mode

Your system can be converted from the tower mode to the rack mode.

To convert your system from the tower mode to the rack mode, you require the tower to rack conversion kit, which contains the following items:

- Rack ears (left and right) with three screws each
- VGA module included with the control panel for rack mode
- A pair of rails (optional)

Safety instructions

 **CAUTION:** Many repairs may only be done by a certified service technician. You should only perform troubleshooting and simple repairs as authorized in your product documentation, or as directed by the online or telephone service and support team. Damage due to servicing that is not authorized by Dell is not covered by your warranty. Read and follow the safety instructions that came with the product.

 **CAUTION:** Do not attempt to convert your system into a rack unless authorized by Dell. Only customers certified by Dell for tower to rack conversion can convert a tower system into a rack system.

 **NOTE:** For specific caution statements and procedures, see the rack installation documentation for your system at dell.com/poweredgemanuals. For complete safety and regulatory information, see the safety instructions that shipped with your system.

Observe the following precautions for stability and safety of the system in rack mode:

- Before installing your equipment in a rack, install the front and side rack stabilizers. Failure to install stabilizers can allow the rack to tip over.
- Always load from the bottom up, and load the heaviest items first.
- Do not overload the AC power supply branch circuit that provides power to the rack.

Preparing a system for conversion from tower mode to rack mode

Prerequisites

1. Ensure that you read the [Safety instructions](#).
2. Keep the #2 Phillips screwdriver ready.
3. Turn off the system, including any attached peripherals, and disconnect the system from the electrical outlet and peripherals.

4. Lay the system on a flat and stable surface.
5. If installed, remove the system feet or caster wheels.
6. Remove the system cover.

Steps

1. Remove the control panel assembly from the chassis.
2. Remove the control panel assembly cover.
3. Install the VGA module.
4. Install the control panel assembly cover for rack mode into the control panel assembly.
5. Remove the system top cover.
6. Install the control panel assembly for rack mode into the chassis.
7. To attach the rack ears, follow the steps below:
 - a. Align the three screw holes on the right rack ear with the screw holes on the right side of the rack system.
 - b. Install the three screws using a #2 Phillips screwdriver.

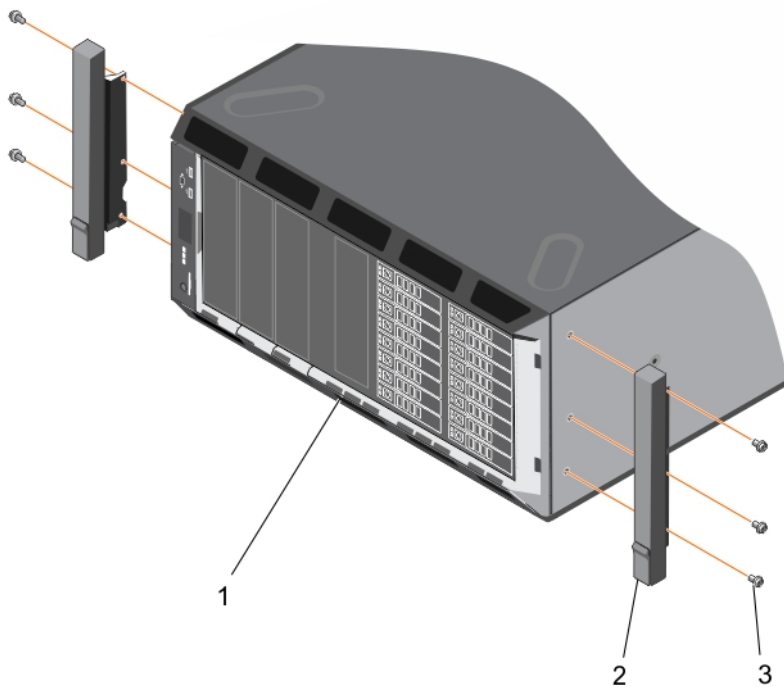

Figure 68. Removing and installing the rack ears

- | | |
|---------------------------------|------------------|
| 1. front panel | 2. rack ears (2) |
| 3. screws for each rack ear (3) | |

Next steps

1. Install the system cover.

2. Install the system in a rack. For more information, see the system's Rack Installation Guide at dell.com/poweredgemanuals.

Related Links

[Removing the system feet](#)

[Removing caster wheels](#)

[Removing the system cover](#)

[Removing the control panel assembly](#)

[Removing the control panel assembly cover](#)

[Installing the VGA module](#)

[Installing the control panel assembly cover](#)

[Removing the system top cover](#)

[Installing the control panel assembly](#)

Troubleshooting your system

Safety first—for you and your system

 **CAUTION:** Many repairs may only be done by a certified service technician. You should only perform troubleshooting and simple repairs as authorized in your product documentation, or as directed by the online or telephone service and support team. Damage due to servicing that is not authorized by Dell is not covered by your warranty. Read and follow the safety instructions that came with the product.

Troubleshooting system startup failure

If you boot the system to the BIOS boot mode after installing an operating system from the UEFI Boot Manager, the system hangs. The reverse is also true. You must boot to the same boot mode in which you installed the operating system.

For all other startup issues, note the system messages that appear on the screen.

Troubleshooting external connections

Ensure that all external cables are securely attached to the external connectors on your system before troubleshooting any external devices.

Troubleshooting the video subsystem

1. Check the system and power connections to the monitor.
2. Check the video interface cabling from the system to the monitor.
3. Run the appropriate diagnostic test.

If the tests run successfully, the problem is not related to video hardware.

If the tests fail, see [Getting Help](#).

Troubleshooting a USB device

About this task

Use the following steps to troubleshoot a USB keyboard/mouse. For other USB devices, go to step 7.

Steps

1. Disconnect the keyboard and mouse cables from the system and reconnect them.
2. If the problem persists, connect the keyboard/mouse to the USB port(s) on the opposite side of the system.

3. If the problem is resolved, restart the system, enter the System Setup, and check if the non-functioning USB ports are enabled.
Check if USB 3.0 is enabled in System Setup. If enabled, disable it and see if the issue is resolved (older operating systems may not support USB 3.0).
4. In the **IDRAC Settings Utility**, ensure the **USB Management Port Mode** is configured as **Automatic** or **Standard OS Use**.
5. Replace the keyboard/mouse with a working keyboard/mouse.
If the problem is not resolved, proceed to the next step to begin troubleshooting other USB devices attached to the system.
6. Power down all attached USB devices and disconnect them from the system.
7. Restart the system and, if your keyboard is functioning, enter the System Setup.
8. Verify that all USB ports are enabled on the **Integrated Devices** screen, in the System Setup options.
9. Check if USB 3.0 is enabled in System Setup. If it is enabled, disable it and restart your system.
If your keyboard is not functioning, you can also use remote access.
10. If the system is not accessible, reset the NVRAM_CLR jumper inside your system and restore the BIOS to the default settings.
11. In the **IDRAC Settings Utility**, ensure the **USB Management Port Mode** is configured as **Automatic** or **Standard OS Use**.
12. Reconnect and power on each USB device one at a time.
13. If a USB device causes the same problem, power down the device, replace the USB cable with a known good cable, and power up the device.

Next steps

If all troubleshooting fails, see [Getting Help](#).

Troubleshooting iDRAC Direct (USB XML configuration)

For information on USB storage device and server configuration, see the Integrated Dell Remote Access Controller User's Guide at dell.com/esmanuals.

Steps

1. Ensure your USB storage device is connect to the front USB Management Port, identified by  icon.
2. Ensure your USB storage device is configured with an NTFS or a FAT32 file system with only one partition.
3. Verify that the USB storage device is configured correctly. For more information on configuring the USB storage device, see the Integrated Dell Remote Access Controller User's Guide at dell.com/esmanuals.
4. In the **IDRAC Settings Utility**, ensure the **USB Management Port Mode** is configured as **Automatic** or **iDRAC Direct Only**.
5. Make sure the **iDRAC Managed: USB XML Configuration** option is either **Enabled** or **Enabled only when the server has default credential settings**.
6. Remove and re-insert the USB storage device.
7. If import operation does not work, try with a different USB storage device.

Next steps

If all troubleshooting fails, see [Getting help](#).

Troubleshooting iDRAC Direct (laptop connection)

For information on USB laptop connection and server configuration, see the Integrated Dell Remote Access Controller User's Guide at dell.com/esmanuals.

Steps

1. Make sure your laptop is connected to the front USB Management Port, identified by  icon with a USB Type A/A cable.
2. In the **iDRAC Settings Utility**, ensure the **USB Management Port Mode** is configured as **Automatic or iDRAC Direct Only**.
3. If the laptop is running the Windows operating system, ensure the iDRAC Virtual USB NIC device driver is installed.
4. If the driver is installed, ensure you are not connected to any network through WiFi or cabled ethernet as iDRAC Direct uses a non-routable address.

Next steps

If all troubleshooting fails, see [Getting help](#).

Troubleshooting a serial I/O device

Steps

1. Turn off the system and any peripheral devices connected to the serial port.
2. Swap the serial interface cable with a working cable, and turn on the system and the serial device.
If the problem is resolved, replace the interface cable with a known good cable.
3. Turn off the system and the serial device, and swap the serial device with a comparable device.
4. Turn on the system and the serial device.

Next steps

If the problem persists, see [Getting Help](#).

Troubleshooting a NIC

Steps

1. Run the appropriate diagnostic test. See [Using System Diagnostics](#) for available diagnostic tests.
2. Restart the system and check for any system messages pertaining to the NIC controller.
3. Check the appropriate indicator on the NIC connector:
 - If the link indicator does not light, check all cable connections.
 - If the activity indicator does not light, the network driver files might be damaged or missing. Remove and reinstall the drivers if applicable. See the NIC documentation.
 - If applicable, change the autonegotiation setting.
 - Use another connector on the switch or hub.
4. Ensure that the appropriate drivers are installed and the protocols are bound. See the NIC documentation.
5. Enter the System Setup and confirm that the NIC ports are enabled on the **Integrated Devices** screen.
6. Ensure that the NICs, hubs, and switches on the network are all set to the same data transmission speed and duplex. See the documentation for each network device.

7. Ensure that all network cables are of the proper type and do not exceed the maximum length.

Next steps

If all troubleshooting fails, see [Getting Help](#).

Troubleshooting a wet system

Prerequisites



CAUTION: Many repairs may only be done by a certified service technician. You should only perform troubleshooting and simple repairs as authorized in your product documentation, or as directed by the online or telephone service and support team. Damage due to servicing that is not authorized by Dell is not covered by your warranty. Read and follow the safety instructions that came with the product.

Steps

1. Turn off the system and attached peripherals, and disconnect the system from the electrical outlet.
2. Remove the system cover.
3. Remove the following components from the system:
 - hard drives
 - hard-drive backplane
 - USB memory key
 - hard-drive tray
 - cooling shroud
 - expansion-card risers (if present)
 - expansion cards
 - power supply unit(s)
 - cooling-fan assembly (if present)
 - cooling fans
 - processor(s) and heat sink(s)
 - memory modules
4. Let the system dry thoroughly for at least 24 hours.
5. Reinstall the components you removed in step 3.
6. Install the system cover.
7. Turn on the system and attached peripherals.
If the system does not start properly, see [Getting Help](#).
8. If the system starts properly, shut down the system, and reinstall all the expansion cards that you removed.
9. Run the appropriate diagnostic test. For more information, see [Using System Diagnostics](#).

Next steps

If the tests fail, see [Getting Help](#).

Troubleshooting a damaged system

Prerequisites

 **CAUTION:** Many repairs may only be done by a certified service technician. You should only perform troubleshooting and simple repairs as authorized in your product documentation, or as directed by the online or telephone service and support team. Damage due to servicing that is not authorized by Dell is not covered by your warranty. Read and follow the safety instructions that came with the product.

Steps

1. Turn off the system and attached peripherals, and disconnect the system from the electrical outlet.
2. Remove the system cover.
3. Ensure that the following components are properly installed:
 - Cooling shroud
 - Expansion-card risers (if present)
 - Expansion cards
 - Power supply(s)
 - Cooling-fan assembly (if present)
 - Cooling fans
 - Processor(s) and heat sink(s)
 - Memory modules
 - Hard-drive carriers
 - Hard-drive backplane
4. Ensure that all cables are properly connected.
5. Install the system cover.
6. Run the appropriate diagnostic test. For more information, see [Using System Diagnostics](#).

Next steps

If the tests fail, see [Getting Help](#).

Troubleshooting the system battery

Prerequisites

 **CAUTION:** Many repairs may only be done by a certified service technician. You should only perform troubleshooting and simple repairs as authorized in your product documentation, or as directed by the online or telephone service and support team. Damage due to servicing that is not authorized by Dell is not covered by your warranty. Read and follow the safety instructions that came with the product.

 **NOTE:** If the system is turned off for long periods of time (for weeks or months), the NVRAM may lose its system configuration information. This situation is caused by a defective battery.

 **NOTE:** Some software may cause the system time to speed up or slow down. If the system seems to operate normally except for the time kept in the System Setup, the problem may be caused by software rather than by a defective battery.

Steps

1. Re-enter the time and date in the System Setup.
2. Turn off the system and disconnect it from the electrical outlet for at least one hour.
3. Reconnect the system to the electrical outlet and turn on the system.
4. Enter the System Setup.
If the date and time are not correct in the System Setup, check the SEL for system battery messages.

Next steps

If the problem persists, see [Getting Help](#).

Troubleshooting power supply units

 **CAUTION:** Many repairs may only be done by a certified service technician. You should only perform troubleshooting and simple repairs as authorized in your product documentation, or as directed by the online or telephone service and support team. Damage due to servicing that is not authorized by Dell is not covered by your warranty. Read and follow the safety instructions that came with the product.

Power source problems

1. Press the power button to ensure that your system is turned on. If the power indicator does not light up when the power button is pressed, press the power-on button firmly.
2. Plug in another working device to ensure that the system board is not faulty.
3. Ensure that no loose connections exist.
For example, loose power cables.
4. Ensure that the power source meets applicable standards.
5. Ensure that there are no short circuits.
6. Have a qualified electrician check the line voltage to ensure that it meets the required specifications.

Power supply unit problems

1. Ensure that no loose connections exist.
For example, loose power cables.
2. Ensure that the power supply handle/LED indicates that the power supply is working properly.
For more information on power supply indicators, see [Indicator codes for redundant power supply](#).
3. If you have recently upgraded your system, ensure that the power supply unit has enough power to support the new system.
4. If you have a redundant power supply configuration, ensure that both the power supply units are of the same type and wattage.
If the LED You may have to upgrade to a higher wattage power supply unit.
5. Ensure that you use only power supply units with the Extended Power Performance (EPP) label on the back.
6. Reseat the power supply unit.

 **NOTE:** After installing a power supply unit, allow several seconds for the system to recognize the power supply unit and determine if it is working properly.

If the problem persists, see [Getting Help](#).

Troubleshooting cooling problems

 **CAUTION:** Many repairs may only be done by a certified service technician. You should only perform troubleshooting and simple repairs as authorized in your product documentation, or as directed by the online or telephone service and support team. Damage due to servicing that is not authorized by Dell is not covered by your warranty. Read and follow the safety instructions that came with the product.

Ensure that the following conditions exist:

- System cover, cooling shroud, EMI filler panel, or back-filler bracket is not removed.
- Ambient temperature is not too high.
- External airflow is not obstructed.
- A cooling fan is not removed or has not failed.
- The expansion card installation guidelines have been followed.

Additional cooling can be added by one of the following methods:

From the iDRAC Web GUI:

1. Click **Hardware** → **Fans** → **Setup**.
2. From the **Fan Speed Offset** drop-down list, select the cooling level needed or set the minimum fan speed to a custom value.

From F2 System Setup

1. Select **iDRAC Settings** → **Thermal**, and set a higher fan speed from the fan speed offset or minimum fan speed.

From RACADM commands

1. Run the command `racadm help system.thermalsettings`

For more information, see the Integrated Dell Remote Access Controller User's Guide at dell.com/esmmanuals.

Troubleshooting cooling fans

Prerequisites

 **CAUTION:** Many repairs may only be done by a certified service technician. You should only perform troubleshooting and simple repairs as authorized in your product documentation, or as directed by the online or telephone service and support team. Damage due to servicing that is not authorized by Dell is not covered by your warranty. Read and follow the safety instructions that came with the product.

 **NOTE:** In the event of a problem with a particular fan, the fan number is referenced by the system's management software, allowing you to easily identify and replace the proper fan by noting the fan numbers on the cooling fan assembly.

Steps

1. Remove the system cover.
2. Reseat the fan or the fan's power cable.

3. Install the system cover.
4. Restart your system.,

Next steps

If the problem persists, see [Getting Help](#).

Troubleshooting system memory

Prerequisites



CAUTION: Many repairs may only be done by a certified service technician. You should only perform troubleshooting and simple repairs as authorized in your product documentation, or as directed by the online or telephone service and support team. Damage due to servicing that is not authorized by Dell is not covered by your warranty. Read and follow the safety instructions that came with the product.

Steps

1. If the system is operational, run the appropriate diagnostic test. See [Using system diagnostics](#) for available diagnostic tests.
If diagnostics indicate a fault, follow the corrective actions provided by the diagnostic program.
2. If the system is not operational, turn off the system and attached peripherals, and unplug the system from the power source. Wait at least 10 seconds and then reconnect the system to the power source.
3. Turn on the system and attached peripherals and note the messages on the screen.
If an error message is displayed indicating a fault with a specific memory module, go to step 12.
4. Enter the System Setup and check the system memory setting. Make any changes to the memory settings, if needed.
If the memory settings match the installed memory but the problem still persists, go to step 12.
5. Turn off the system and attached peripherals, and disconnect the system from the electrical outlet.
6. Remove the system cover.
7. Check the memory channels and ensure that they are populated correctly.
 **NOTE:** See the system event log or system messages for the location of the failed memory module. Reinstall the memory device.
8. Reseat the memory modules in their sockets.
9. Install the system.
10. Enter the System Setup and check the system memory setting.
If the problem is not resolved, proceed with the next step.
11. Remove the system cover.
12. If a diagnostic test or error message indicates a specific memory module as faulty, swap or replace the module with a known good memory module.
13. To troubleshoot an unspecified faulty memory module, replace the memory module in the first DIMM socket with a module of the same type and capacity.
If an error message is displayed on the screen, this may indicate a problem with the installed DIMM type(s), incorrect DIMM installation, or defective DIMM(s). Follow the on-screen instructions to resolve the problem. See [General memory module installation guidelines](#).
14. Install the system cover.
15. As the system boots, observe any error message that is displayed and the diagnostic indicators on the front of the system.

16. If the memory problem persists, repeat step 12 through step 15 for each memory module installed.

Next steps

If the problem persists after all memory modules have been checked, see [Getting Help](#).

Troubleshooting an internal USB key

Prerequisites



CAUTION: Many repairs may only be done by a certified service technician. You should only perform troubleshooting and simple repairs as authorized in your product documentation, or as directed by the online or telephone service and support team. Damage due to servicing that is not authorized by Dell is not covered by your warranty. Read and follow the safety instructions that came with the product.

Steps

1. Enter the System Setup and ensure that the **USB key port** is enabled on the **Integrated Devices** screen.
2. Turn off the system and attached peripherals, and disconnect the system from the electrical outlet.
3. Remove the system cover.
4. Locate the USB key and reseal it.
5. Install the system cover.
6. Turn on the system and attached peripherals and check if the USB key is functioning.
7. If the problem is not resolved, repeat step 2 and step 3.
8. Insert a different USB key that you know works properly.
9. Install the system cover.

Next steps

If the problem is not resolved, see [Getting Help](#).

Troubleshooting an SD card

Prerequisites



CAUTION: Many repairs may only be done by a certified service technician. You should only perform troubleshooting and simple repairs as authorized in your product documentation, or as directed by the online or telephone service and support team. Damage due to servicing that is not authorized by Dell is not covered by your warranty. Read and follow the safety instructions that came with the product.



NOTE: Certain SD cards have a physical write-protect switch on the card. If the write-protect switch is turned on, the SD card is not writeable.

Steps

1. Enter the System Setup and ensure that the **Internal SD Card Port** is enabled.
2. Turn off the system, including any attached peripherals, and disconnect the system from the electrical outlet.
3. Remove the system cover.

 **NOTE:** When an SD card failure occurs, the internal dual SD module controller notifies the system. On the next restart, the system displays a message indicating the failure. If redundancy is enabled at the time of SD card failure, a critical alert will be logged and chassis health will degrade.

4. Replace the failed SD card with a new SD card.
5. Install the system cover.
6. Reconnect the system to its electrical outlet and turn the system on, including any attached peripherals.
7. Enter the System Setup and ensure that the **Internal SD Card Port** and **Internal SD Card Redundancy** mode is set to the required mode.
Verify that correct SD slot is set as **Primary SD Card**.
8. Check if the SD card is functioning properly.
9. If the **Internal SD Card Redundancy** option is set to **Enabled** at the time of the SD card failure, the system will prompt you to perform a rebuild.

 **NOTE:** The rebuild will always be sourced from the primary SD card to the secondary SD card. Perform the rebuild of the SD card as necessary.

Troubleshooting an optical drive

Prerequisites

 **CAUTION:** Many repairs may only be done by a certified service technician. You should only perform troubleshooting and simple repairs as authorized in your product documentation, or as directed by the online or telephone service and support team. Damage due to servicing that is not authorized by Dell is not covered by your warranty. Read and follow the safety instructions that came with the product.

Steps

1. Try using a different CD or DVD.
2. Enter the System Setup and ensure that the integrated SATA controller and the drive's SATA port are enabled.
3. Run the appropriate diagnostic test.
4. Turn off the system and attached peripherals, and disconnect the system from the electrical outlet.
5. If installed, remove the front bezel.
6. Remove the system cover.
7. Ensure that the interface cable is securely connected to the optical drive and to the controller.
8. Ensure that a power cable is properly connected to the drive.
9. Install the system cover.

Next steps

If the problem is not resolved, see [Getting Help](#).

Troubleshooting a tape backup unit

Prerequisites

 **CAUTION:** Many repairs may only be done by a certified service technician. You should only perform troubleshooting and simple repairs as authorized in your product documentation, or as directed by the online or telephone service and support team. Damage due to servicing that is not authorized by Dell is not covered by your warranty. Read and follow the safety instructions that came with the product.

Steps

1. Use a different tape cartridge.
2. Ensure that the device drivers for the tape backup unit are installed and are configured correctly. See your tape drive documentation for more information about device drivers.
3. Reinstall the tape-backup software as instructed in the tape-backup software documentation.
4. Ensure that the interface cable of the tape drive is connected to the external port on the controller card.
5. Perform the following steps to ensure that the controller card is properly installed:
 - a. Turn off the system and attached peripherals, and disconnect the system from the electrical outlet.
 - b. Remove the system cover.
 - c. Reseat the controller card in the expansion card slot.
 - d. Install the system cover.
 - e. Turn on the system and attached peripherals.
6. Run the appropriate diagnostic test. For more information, see [Using System Diagnostics](#).

Next steps

If you cannot resolve the problem, see [Getting Help](#).

Troubleshooting a hard drive

Prerequisites

 **CAUTION:** Many repairs may only be done by a certified service technician. You should only perform troubleshooting and simple repairs as authorized in your product documentation, or as directed by the online or telephone service and support team. Damage due to servicing that is not authorized by Dell is not covered by your warranty. Read and follow the safety instructions that came with the product.

 **CAUTION:** This troubleshooting procedure can erase data stored on the hard drive. Before you proceed, back up all files on the hard drive.

Steps

1. Run the appropriate diagnostic test. For more information, see [Using System Diagnostics](#). Depending on the results of the diagnostics test, proceed as needed through the following steps.
2. If your system has a RAID controller and your hard drives are configured in a RAID array, perform the following steps:
 - a. Restart the system and press <F10> during system startup to run the Lifecycle Controller, and then run the Hardware Configuration wizard to check the RAID configuration. See the Lifecycle Controller documentation or online help for information on RAID configuration.
 - b. Ensure that the hard drive(s) are configured correctly for the RAID array.

- c. Take the hard drive offline and reseal the drive.
- d. Exit the configuration utility and allow the system to boot to the operating system.
3. Ensure that the required device drivers for your controller card are installed and are configured correctly. See the operating system documentation for more information.
4. Restart the system and enter the System Setup.
5. Verify that the controller is enabled and the drives are displayed in the System Setup.

Next steps

If the problem persists, try troubleshooting the expansion cards or see [Getting Help](#).

Troubleshooting a storage controller

 **CAUTION:** Many repairs may only be done by a certified service technician. You should only perform troubleshooting and simple repairs as authorized in your product documentation, or as directed by the online or telephone service and support team. Damage due to servicing that is not authorized by Dell is not covered by your warranty. Read and follow the safety instructions that came with the product.

 **NOTE:** When troubleshooting a SAS or PERC controller, see the documentation for your operating system and the controller.

1. Run the appropriate diagnostic test. For more information, see [Using System Diagnostics](#).
2. Turn off the system and attached peripherals, and disconnect the system from the electrical outlet.
3. Remove the system cover.
4. Verify that the installed expansion cards are compliant with the expansion card installation guidelines.
5. Ensure that each expansion card is firmly seated in its connector.
6. Install the system cover.
7. Reconnect the system to the electrical outlet, and turn on the system and attached peripherals.
8. If the problem is not resolved, turn off the system and attached peripherals, and disconnect the system from the electrical outlet.
9. Remove the system cover.
10. Remove all expansion cards installed in the system.
11. Install the system cover.
12. Reconnect the system to the electrical outlet, and turn on the system and attached peripherals.
13. Run the appropriate diagnostic test. For more information, see [Using System Diagnostics](#). If the tests fail, see [Getting Help](#).
14. For each expansion card you removed in step 10, perform the following steps:
 - a. Turn off the system and attached peripherals, and disconnect the system from the electrical outlet.
 - b. Remove the system cover.
 - c. Reinstall one of the expansion cards.
 - d. Install the system cover.
 - e. Run the appropriate diagnostic test. For more information, see [Using System Diagnostics](#).

If the tests fail, see [Getting Help](#).

Troubleshooting expansion cards

Prerequisites

 **CAUTION:** Many repairs may only be done by a certified service technician. You should only perform troubleshooting and simple repairs as authorized in your product documentation, or as directed by the online or telephone service and support team. Damage due to servicing that is not authorized by Dell is not covered by your warranty. Read and follow the safety instructions that came with the product.

 **NOTE:** When troubleshooting an expansion card, see the documentation for your operating system and the expansion card.

Steps

1. Run the appropriate diagnostic test. For more information, see [Using System Diagnostics](#).
2. Turn off the system and attached peripherals, and disconnect the system from the electrical outlet.
3. Remove the system cover.
4. Ensure that each expansion card is firmly seated in its connector.
5. Install the system cover.
6. If the problem is not resolved, turn off the system and attached peripherals, and disconnect the system from the electrical outlet.
7. Remove the system cover.
8. Remove all expansion cards installed in the system.
9. Install the system cover.
If the tests fail, see [Getting Help](#).
10. For each expansion card you removed in step 8, perform the following steps:
 - a. Turn off the system and attached peripherals, and disconnect the system from the electrical outlet.
 - b. Remove the system cover.
 - c. Reinstall one of the expansion cards.
 - d. Install the system cover.
 - e. Run the appropriate diagnostic test. For more information, see [Using System Diagnostics](#).

Next steps

If the problem persists, see [Getting Help](#).

Troubleshooting processors

Prerequisites

 **CAUTION:** Many repairs may only be done by a certified service technician. You should only perform troubleshooting and simple repairs as authorized in your product documentation, or as directed by the online or telephone service and support team. Damage due to servicing that is not authorized by Dell is not covered by your warranty. Read and follow the safety instructions that came with the product.

Steps

1. Run the appropriate diagnostics test. See [Using System Diagnostics](#) for available diagnostic tests.
2. Turn off the system and attached peripherals, and disconnect the system from the electrical outlet.
3. Remove the system cover.

4. Ensure that the processor and heat sink are properly installed.
5. Install the system cover.
6. Run the appropriate diagnostic test. For more information, see [Using System Diagnostics](#).

Next steps

If the problem persists, see [Getting Help](#).

System messages

For a list of event and error messages generated by the system firmware and agents that monitor system components, see the Dell Event and Error Messages Reference Guide at dell.com/esmmanuals.

Warning messages

A warning message alerts you to a possible problem and prompts you to respond before the system continues a task. For example, before you format a hard drive, a message warns you that you may lose all data on the hard drive. Warning messages usually interrupt the task and require you to respond by typing y (yes) or n (no).

 **NOTE:** Warning messages are generated by either the application or the operating system. For more information, see the documentation that accompanied the operating system or application.

Diagnostic messages

The system diagnostic utilities may issue messages if you run diagnostic tests on your system. See [Using system diagnostics](#) for more information about system diagnostics.

Alert messages

The systems management software generates alert messages for your system. Alert messages include information, status, warning, and failure messages for drive, temperature, fan, and power conditions. For more information, see the systems management software documentation.

Using system diagnostics

If you experience a problem with your system, run the system diagnostics before contacting Dell for technical assistance. The purpose of running system diagnostics is to test your system hardware without requiring additional equipment or risking data loss. If you are unable to fix the problem yourself, service and support personnel can use the diagnostics results to help you solve the problem.

Dell Embedded System Diagnostics

 **NOTE:** The Dell Embedded System Diagnostics is also known as Enhanced Pre-boot System Assessment (ePSA) diagnostics.

The embedded system diagnostics provides a set of options for particular device groups or devices allowing you to:

- Run tests automatically or in an interactive mode
- Repeat tests
- Display or save test results
- Run thorough tests to introduce additional test options to provide extra information about the failed device(s)
- View status messages that inform you if tests are completed successfully
- View error messages that inform you of problems encountered during testing

When to use the Embedded System Diagnostics

If a major component or device in the system does not operate properly, running the embedded system diagnostics may indicate component failure.

Running the Embedded System Diagnostics from Boot Manager

1. As the system boots, press <F11>.
2. Use the up and down arrow keys to select **System Utilities** → **Launch Diagnostics**.
The **ePSA Pre-boot System Assessment** window is displayed, listing all devices detected in the system. The diagnostics starts executing the tests on all the detected devices.

Running the Embedded System Diagnostics from the Dell Lifecycle Controller

1. As the system boots, press <F11>.
2. Select **Hardware Diagnostics** → **Run Hardware Diagnostics**.
The **ePSA Pre-boot System Assessment** window is displayed, listing all devices detected in the system. The diagnostics starts executing the tests on all the detected devices.

System diagnostic controls

Menu	Description
Configuration	Displays the configuration and status information of all detected devices.
Results	Displays the results of all tests that are executed.
System health	Provides the current overview of the system performance.
Event log	Displays a time-stamped log of the results of all tests run on the system. This is displayed if at least one event description is recorded.

For information about embedded system diagnostics, see the *ePSA Diagnostics Guide (Notebooks, Desktops and Servers)* at dell.com/support/home.

Jumpers and connectors

System board connectors

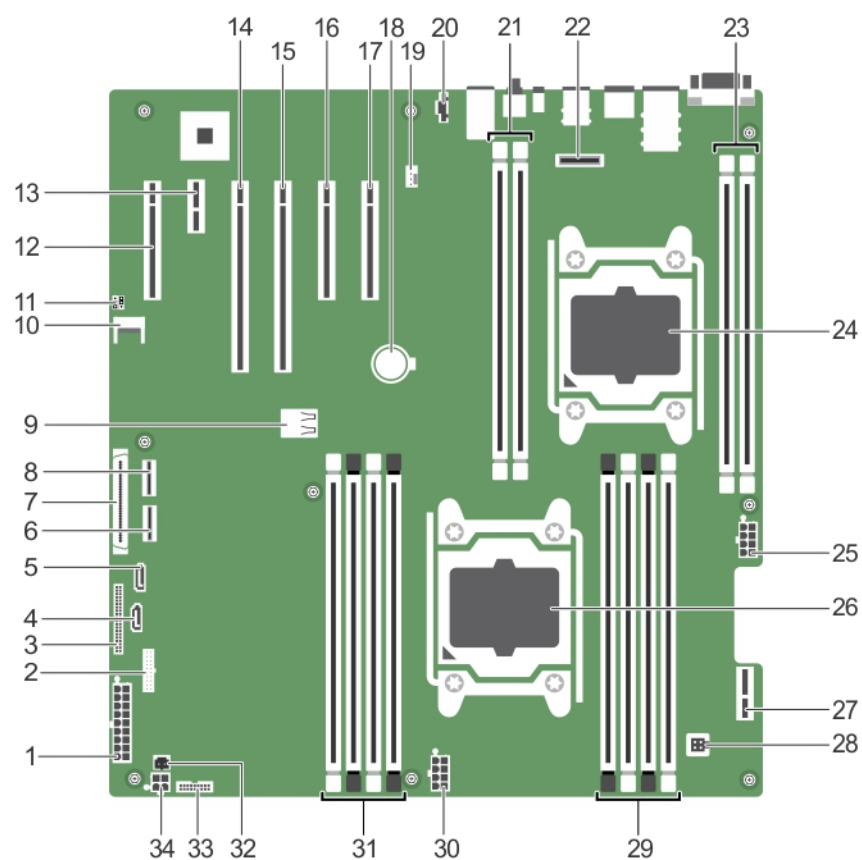

Figure 69. System board connectors

Item	Connector	Description
1	SYS_PWR_CONN (P1)	Power connector
2	FP_USB	Control panel USB connector
3	PIB_CONN	PIB signal connector
4	SATA_CDROM	Optical drive SATA connector





Item	Connector	Description
5	SATA_TBU	Tape drive SATA connector
6	J_SATA_B	SATA connector B
7	CTRL_PNL	Control panel interface connector
8	J_SATA_A	SATA connector A
9	INT_USB_3.0	Internal USB connector
10	TPM_MODULE	Trusted Platform Module (TPM) connector
11	J_PSWD_NVRAM	See System Board Jumper Settings
12	SLOT1 PCIE_G2_X4 (PCH)	PCIe card connector 1
13	SLOT2 PCIE_G2_X1 (PCH)	PCIe card connector 2
14	SLOT3 PCIE_G3_X16 (CPU1)	PCIe card connector 3
15	SLOT4 PCIE_G3_X16 (CPU1)	PCIe card connector 4
16	SLOT5 PCIE_G3_X8 (CPU2)	PCIe card connector 5
17	SLOT6 PCIE_G3_X8 (CPU2)	PCIe card connector 6
18	BATTERY	System battery
19	FAN1	Internal cooling fan connector
20	FAN2	External cooling fan connector
21	B1, B2	Memory module sockets
22	J_AMEA	Advanced Management Enablement Adapter (AMEA) connector
23	B4, B3	Memory module sockets
24	CPU2	Processor 2
25	PWR_CONN_C (P3)	CPU2 power connector
26	CPU1	Processor 1
27	IDSDM	Internal dual SD module connector
28	INTRUSION	Intrusion switch connector
29	A1, A5, A2, A6	Memory module sockets
30	PWR_CONN_B (P2)	CPU1 power connector
31	A8, A4, A7, A3	Memory module sockets
32	ACT_LED	Front-panel hard-drive LED controller connector

Item	Connector	Description
33	BP_SIG	Backplane signal connector
34	ODD_PWR	Optical drive power connector

System board jumper settings

For information on resetting the password jumper to disable a password, see [Disabling a Forgotten Password](#).

Table 5. System board jumper settings

Jumper	Setting	Description
PWRD_EN	 (default)	The password reset feature is enabled (pins 2–4).
		The password reset feature is disabled (pins 4–6). The iDRAC local access is unlocked at the next AC power cycle.
NVRAM_CLR	 (default)	The configuration settings are retained at the next system boot (pins 3–5).
		The configuration settings are cleared at system boot (pins 1–3).

Disabling a forgotten password

The system's software security features include a system password and a setup password. The password jumper enables these password features or disables them and clears any password(s) currently in use.

Prerequisites

CAUTION: Many repairs may only be done by a certified service technician. You should only perform troubleshooting and simple repairs as authorized in your product documentation, or as directed by the online or telephone service and support team. Damage due to servicing that is not authorized by Dell is not covered by your warranty. Read and follow the safety instructions that came with the product.

Steps

1. Turn off the system, including any attached peripherals, and disconnect the system from the electrical outlet.
2. Open the system.
3. Move the jumper on the system-board jumper from pins 4 and 6 to pins 2 and 4.
4. Close the system.

The existing passwords are not disabled (erased) until the system boots with the jumper on pins 2 and 4. However, before you assign a new system and/or setup password, you must move the jumper back to pins 4 and 6.

NOTE: If you assign a new system and/or setup password with the jumper on pins 2 and 4, the system disables the new password(s) the next time it boots.

5. Reconnect the system to its electrical outlet and turn the system on, including any attached peripherals.

- 6.** Turn off the system, including any attached peripherals, and disconnect the system from the electrical outlet.
- 7.** Open the system.
- 8.** Move the jumper on the system-board jumper from pins 2 and 4 to pins 4 and 6.
- 9.** Close the system.
- 10.** Reconnect the system to its electrical outlet and turn the system on, including any attached peripherals.
- 11.** Assign a new system and/or setup password.

Technical Specifications

Physical	
Height	443.3 mm (17.45 inch) with feet 430.3 mm (16.94 inch) without feet
Width	304.5 mm (11.98 inch) with feet opened 218 mm (8.58 inch) with feet closed
Depth	542.2 mm (21.35 inch) without bezel 558.6 mm (21.99 inch) with bezel
Weight (maximum configuration)	30.16 kg (66.49 lb)
Processor	
Processor type	One or two Intel Xeon processors E5-2600 v3 product family
Expansion Bus	
Bus type	PCI Express Generation 2 and 3
Expansion slots	<p>(Slot 1) One full-height, half-length x4 PCIe Gen2 card slot connected to Platform Controller Hub (PCH)</p> <p>(Slot 2) One full-height, half-length x1 PCIe Gen2 card slot connected to PCH</p> <p>(Slot 3) One full-height, full-length x16 PCIe Gen3 card slot connected to processor 1</p> <p>(Slot 4) One full-height, full-length x16 PCIe Gen3 card slot connected to processor 1</p> <p>(Slot 5) One full-height, half-length x8 PCIe Gen3 card slot connected to processor 2</p> <p>(Slot 6) One full-height, half-length x8 PCIe Gen3 card slot connected to processor 2</p>

Memory

Architecture	1333 MT/s, 1600 MT/s, 1866 MT/s, or 2133 MT/s DDR4 Registered DIMMs Support for advanced ECC or memory optimized operation
Memory module sockets	Twelve 288-pin
Memory module capacities (RDIMMs)	4 GB (single-rank), 8 GB (single- and dual-rank), 16 GB (single- and dual-rank), and 32 GB (single- and dual-rank)
Minimum RAM	4 GB with a single processor 8 GB with a dual processor
Maximum RAM	Up to 192 GB with single processor Up to 384 GB with dual processor

Power

AC power supply (per power supply)

Wattage	450 W, 495 W, 750 W, or 1100 W
Power rating per power supply unit	1100 W (Platinum) AC (100 – 240 V, 50/60 Hz, 12 A – 6.5 A) 750 W (Platinum) AC (100 – 240 V, 50/60 Hz, 10 A – 5 A) 495 W (Platinum) AC (100 – 240 V, 50/60 Hz, 6.5 A – 3 A) 450 W (Bronze) AC (100 – 240 V, 50/60 Hz, 6.5 A – 3.5 A)

Heat dissipation

 NOTE: Heat dissipation is calculated using the power supply wattage rating.	1871 BTU/hr maximum (450 W power supply) 1908 BTU/hr maximum (495 W power supply) 2891 BTU/hr maximum (750 W power supply) 4100 BTU/hr maximum (1100 W power supply)
--	---

Voltage

 NOTE: This system is also designed to be connected to IT power systems with a phase to phase voltage not exceeding 230 V.	100–240 V AC, autoranging, 50/60 Hz
--	-------------------------------------

Drives

Hard drives

Four-hard-drive systems

Up to four 3.5 inch, internal, cabled SATA, or nearline SAS hard drives.

Eight-hard-drive systems

Up to eight 3.5 inch, internal, hot-swappable SATA, or nearline SAS hard drives.

 **NOTE:** 2.5 inch hard drives in 3.5 inch carriers are supported for SAS, and SATA SSD hard drives.

Sixteen-hard-drive systems

Up to sixteen 2.5 inch, internal, hot-swappable SATA, nearline SAS, SAS, or SATA SSD hard drives.

Optical drive

One optional SATA DVD-ROM drive or DVD+/-RW drive.

 **NOTE:** If your system is installed with a double-width GPU card, the system supports only one 5.25 inch removable media storage device.

Tape drive

Up to two optional 5.25 inch tape drive.

 **NOTE:** If your system is installed with a double-width GPU card, the system supports only one 5.25 inch removable media storage device.

Connectors

Back

NIC

Two 10/100/1000 Mbps

Serial

DB-9 Serial Port connector

USB

Six Hi-Speed USB Host (five USB 2.0 and one USB 3.0)

Video

15-pin VGA

iDRAC8

One optional 1 GbE Ethernet

SD vFlash

One optional SD vFlash memory card

Front

USB

Two Hi-Speed USB Host (One USB 2.0 and one USB 3.0)

Video

15-pin VGA

 **NOTE:** The front VGA port is available only with the rack configuration.

Connectors

Internal

USB	One 9-pin, USB 3.0-compliant
Internal Dual SD Module	Two optional flash memory card slots with the internal SD module

 **NOTE:** One card slot is dedicated for redundancy.

Video

Video type	Integrated Matrox G200 with iDRAC8
Video memory	16 MB shared with iDRAC8 application memory

Expanded Operating Temperature

 **NOTE:** When operating in the expanded temperature range, system performance may be impacted.

 **NOTE:** When operating in the expanded temperature range, ambient temperature warnings may be reported on the LCD and in the System Event Log.

≤ 10% of annual operating hours

5 °C to 40 °C at 5% to 85% RH with 26 °C dew point.

 **NOTE:** Outside the standard operating temperature (10 °C to 35 °C), the system can operate down to 5 °C or up to 40 °C for a maximum of 10% of its annual operating hours.

For temperatures between 35 °C and 40 °C, de-rate maximum allowable dry bulb temperature by 1 °C per 175 m above 950 m (1 °F per 319 ft).

≤ 1% of annual operating hours

–5 °C to 45 °C at 5% to 90% RH with 26 °C dew point.

 **NOTE:** Outside the standard operating temperature (10 °C to 35 °C), the system can operate down to –5 °C or up to 45 °C for a maximum of 1% of its annual operating hours.

For temperatures between 40 °C and 45 °C, de-rate maximum allowable dry bulb temperature by 1 °C per 125 m above 950 m (1 °F per 228 ft).

Expanded Operating Temperature Restrictions

- For low-power CPUs (55 W/ 65 W), both the internal cooling fan and the external cooling fan need to be installed.
- The operating temperature specified is for a maximum altitude of 3048 m (10,000 ft).
- GPU card is not supported.
- LRDIMM is not supported.

Expanded Operating Temperature

- Non-redundant power supplies are not supported.
- Cabled power supply units are not supported.
- Non Dell qualified peripheral cards and/or peripheral cards greater than 25 W are not supported.

Environmental

 **NOTE:** For additional information about environmental measurements for specific system configurations, see dell.com/environmental_datasheets.

Temperature

Maximum Temperature Gradient (Operating and Storage)	20 °C/h (36 °F/h)
Storage Temperature Limits	-40 °C to 65 °C (-40 °F to 149 °F)

Relative Humidity

Storage	5% to 95% RH with 33 °C (91 °F) maximum dew point. Atmosphere must be non-condensing at all times.
---------	--

Temperature (Continuous Operation)

Temperature Ranges (for altitude less than 950 m or 3117 ft)	10 °C to 35 °C (50 °F to 95 °F) with no direct sunlight on the equipment.
Humidity Percentage Range	10% to 80% Relative Humidity with 29 °C (84.2 °F) maximum dew point.

Maximum Vibration

Operating	0.26 G _{rms} at 5 Hz to 350 Hz (all operation orientations).
Storage	1.88 G _{rms} at 10 Hz to 500 Hz for 15 min (all six sides tested).

Maximum Shock

Operating	Six consecutively executed shock pulses in the positive and negative x, y, and z axes of 40 G for up to 2.3 ms.
Storage	Six consecutively executed shock pulses in the positive and negative x, y, and z axes (one pulse on each side of the system) of 71 G for up to 2 ms.

Maximum Altitude

Operating	3,048 m (10,000 ft)
Storage	12,000 m (39,370 ft).

Environmental

Operating Altitude De-rating

Up to 35 °C (95 °F)	Maximum temperature is reduced by 1 °C/300 m (1 °F/547 ft) above 950 m (3,117 ft).
35 °C to 40 °C (95 °F to 104 °F)	Maximum temperature is reduced by 1 °C/175 m (1 °F/319 ft) above 950 m (3,117 ft).
40 °C to 45 °C (104 °F to 113 °F)	Maximum temperature is reduced by 1 °C/125 m (1 °F/228 ft) above 950 m (3,117 ft).

Particulate Contamination

 **NOTE:** This section defines the limits to help avoid IT equipment damage and/or failure from particulates and gaseous contamination. If it is determined that levels of particulates or gaseous pollution are beyond the limits specified below and are the reason for the damage and/or failures to your equipment, it may be necessary for you to re-mediate the environmental conditions that are causing the damage and/or failures. Re-mediation of environmental conditions will be the responsibility of the customer.

Air Filtration

 **NOTE:** Applies to data center environments only. Air filtration requirements do not apply to IT equipment designed to be used outside a data center, in environments such as an office or factory floor.

Data center air filtration as defined by ISO Class 8 per ISO 14644-1 with a 95% upper confidence limit.

 **NOTE:** Air entering the data center must have MERV11 or MERV13 filtration.

Conductive Dust

 **NOTE:** Applies to data center and non-data center environments.

Air must be free of conductive dust, zinc whiskers, or other conductive particles.

Corrosive Dust

 **NOTE:** Applies to data center and non-data center environments.

- Air must be free of corrosive dust.
- Residual dust present in the air must have a deliquescent point less than 60% relative humidity.

Gaseous Contamination

 **NOTE:** Maximum corrosive contaminant levels measured at $\leq 50\%$ relative humidity.

Copper Coupon Corrosion Rate <300 Å/month per Class G1 as defined by ANSI/ISA71.04-1985.

Silver Coupon Corrosion Rate <200 Å/month as defined by AHSRAE TC9.9.

Getting help

Contacting Dell

Dell provides several online and telephone-based support and service options. If you do not have an active Internet connection, you can find contact information on your purchase invoice, packing slip, bill, or Dell product catalog. Availability varies by country and product, and some services may not be available in your area. To contact Dell for sales, technical support, or customer-service issues:

1. Go to **dell.com/support**.
2. Select your country from the drop-down menu on the bottom right corner of the page.
3. For customized support:
 - a. Enter your system Service Tag in the **Enter your Service Tag** field.
 - b. Click **Submit**.
4. For general support:
 - a. Select your product category.
 - b. Select your product segment.
 - c. Select your product.

The support page that lists the various support categories is displayed.

The support page that lists the various support categories is displayed.

Locating your system Service Tag

Your system is identified by a unique Express Service Code and Service Tag number. The Express Service Code and Service Tag are found on the front of the system by pulling out the information tag. Alternatively, the information may be on a sticker on the chassis of the system. This information is used by Dell to route support calls to the appropriate personnel.

Quick Resource Locator

Use the Quick Resource Locator (QRL) to get immediate access to system information and how-to videos. This can be done by visiting **dell.com/QRL** or by using your smartphone or tablet and a model specific Quick Resource (QR) code located on your Dell PowerEdge system. To try out the QR code, scan the following image.



Quick Resource Locator



www.dell.com/QRL/Server/T430